

# Frame Shot Plus

## User Manual

February 22, 2026

SKUs: FR-SHOT-PLUS-V1B, FR-SHOT-PLUS-V1B-BK, FR-SHOT-PLUS-V1B-SBK

Language: English



# I Disclaimer

---

Before using this product, please read and fully understand all instructions provided. This product is classified as Class A equipment and is intended for use by commercial customers only. It is not suitable for residential use and may cause interference in residential environments.

For the most up-to-date specifications, refer to the latest SKAARHOJ data sheets or publications. Availability of products and types may vary by country —please check with a SKAARHOJ sales representative for details.

The information in this document is subject to change without notice. While SKAARHOJ strives to ensure the quality, reliability, and safety of its products, defects cannot be entirely ruled out. To minimize risks of damage or injury, customers must implement appropriate safety measures and follow the intended use guidelines.

SKAARHOJ and its subsidiaries disclaim any liability, warranty, or responsibility for claims, whether in contract, tort, or any other legal theory. SKAARHOJ shall not be liable for any special, direct, indirect, incidental, or consequential damages, including lost profits, revenues, or economic losses, or for third-party claims, equipment replacement, or any other damages.

SKAARHOJ does not assume liability for patent, copyright, or intellectual property infringement arising from the use of its products. No license or rights are granted under any patents or intellectual property of SKAARHOJ or third parties.

If any of the above clauses are not permitted by applicable law, they will be enforced to the maximum extent allowed.

## II Imprint

---

© 2026 SKAARHOJ. All rights reserved.

This device contains proprietary information of SKAARHOJ and is provided under a license agreement with restrictions on use and disclosure, protected by copyright law. Reverse engineering of the hardware and software is prohibited.

No part of this publication may be distributed, reproduced, transmitted, transcribed, stored in a data retrieval system, or translated into any language in any form by any means without prior written permission from SKAARHOJ.

If you download files from our website for personal use, ensure you check for updated versions. SKAARHOJ cannot be held liable for downloaded files, as technical data is subject to change without notice.

Due to ongoing product development, the information in this document may change without notice. The information and intellectual property contained herein is confidential between SKAARHOJ and the client and remains SKAARHOJ's exclusive property. Please report any issues with the documentation in writing. SKAARHOJ does not guarantee this document is error-free.

The source language of this manual is English. Translations into other languages are derived from the English version.

For further assistance:

SKAARHOJ ApS  
Rosenkaeret 11C  
DK-2860 Soeborg  
Denmark  
Email: [info@skaarhoj.com](mailto:info@skaarhoj.com)  
Website: [www.skaarhoj.com](http://www.skaarhoj.com)

### II.1 Trademarks

SKAARHOJ® is a registered trademark of SKAARHOJ ApS. The following names are also trademarks of SKAARHOJ: Raw Panel™, Blue Pill™, Reactor™, UniSketch™, Device Core™, and Frame Shot Plus™.

All other trademarks are the property of their respective owners and are acknowledged as such.

### III Document Legends

---

This section explains the meaning of various alert levels and informational notes used throughout this document. Each label serves as a guide to indicate the level of attention required and the type of risk involved. Please review these legends carefully to ensure a clear understanding of the warnings, cautions, and helpful tips provided.

#### **Danger**

DANGER indicates an imminent hazard. Failure to avoid it will result in death or serious injury. Always follow the recommended actions to prevent this danger.

#### **Warning**

WARNING indicates a potential hazard. Failure to avoid it may result in death or serious injury. Always follow the recommended actions to prevent this risk.

#### **Caution**

CAUTION indicates a possible hazard. Failure to avoid it may result in minor or moderate injuries. Always follow the recommended actions to prevent this hazard.

#### **Notice**

NOTICE indicates a potential risk of equipment or environmental damage. Always follow the recommended actions to avoid damage.

#### **Hint**

HINT provides additional information to clarify or simplify a procedure. It is not related to safety.

# Contents

---

<b>I Disclaimer</b>	<b>1</b>
<b>II Imprint</b>	<b>2</b>
II.1 Trademarks . . . . .	2
<b>III Document Legends</b>	<b>3</b>
<b>1 About this Document</b>	<b>5</b>
<b>2 Safety Information</b>	<b>6</b>
<b>3 About Frame Shot Plus</b>	<b>7</b>
3.1 Feature Highlights . . . . .	7
3.2 Intended Use . . . . .	8
3.3 Product Identification . . . . .	8
3.4 Environmental Conditions . . . . .	8
3.5 Technical Data and Dimensions . . . . .	8
3.5.1 Standard Connections . . . . .	8
3.5.2 Functional Earth . . . . .	10
3.5.3 Technical Drawing . . . . .	10
3.5.4 Technical Data . . . . .	10
3.5.5 Hardware Components . . . . .	10
3.6 Scope of Delivery and Warranty . . . . .	12
3.6.1 Recommended Accessories . . . . .	13
3.7 Certification and Safety Standards . . . . .	13
3.7.1 EU Declaration of Conformity . . . . .	13
3.7.2 Regulatory Compliance Information . . . . .	13
<b>4 Getting Started</b>	<b>15</b>
4.1 Network Requirements . . . . .	15
4.1.1 Network Layout . . . . .	15
4.2 Accessing Frame Shot Plus . . . . .	16
4.2.1 DHCP or Static IP . . . . .	16
4.2.2 Wi-Fi Access Point . . . . .	17
4.2.3 Link from SKAARHOJ Firmware Updater . . . . .	18

4.2.4	SKAARHOJ Firmware Updater and Micro USB . . . . .	19
4.3	Selecting Default Configuration . . . . .	20
4.4	Adding Devices . . . . .	21
4.4.1	Auto Discover . . . . .	21
4.4.2	Manual Add . . . . .	22
4.4.3	Device Details . . . . .	23
4.4.4	Populating Settings Tables . . . . .	23
4.5	Beyond Default Configurations . . . . .	25
<b>5</b>	<b>Service</b>	<b>26</b>
5.1	Troubleshooting . . . . .	26
5.2	Cleaning . . . . .	26
5.3	Repair . . . . .	27
5.4	Disposal . . . . .	28
5.5	Transportation and Storage . . . . .	28
5.6	SKAARHOJ Service Contacts . . . . .	29
<b>6</b>	<b>Notes</b>	<b>30</b>

# 1 About this Document

---

This operating manual is intended for all users of the SKAARHOJ Frame Shot Plus. It provides essential guidelines for safe and proper operation of the device. All users must read this manual before using the device for the first time to ensure correct usage.

The manual is an important part of the Frame Shot Plus and should be kept easily accessible, close to the device for reference at any time.

For more detailed information about the device's features and functionality, please refer to additional instructions available for download at [www.skaarhoj.com](http://www.skaarhoj.com) or request them via [support@skaarhoj.com](mailto:support@skaarhoj.com).

Ensure that the operating manual, user manual, and any other relevant documentation are stored safely for future reference and for any potential future users of the device.

For more resources and helpful information, visit the SKAARHOJ website.

SKAARHOJ offers comprehensive training courses to provide deeper insights into maximizing the potential of SKAARHOJ products.

## 2 Safety Information

---

This safety information supplements the specific operating instructions and must be strictly followed. Before operating or installing the device, read and understand all safety and operating instructions. Keep these instructions for future reference. Always follow the guidelines in this and any other documentation provided to avoid injury or damage to the device and surrounding objects.

Assembly and operation should only be performed by trained personnel familiar with the device. Use only the recommended tools, materials, and procedures outlined in this document. For other equipment, refer to the manufacturer's instructions.

Safety instructions, warning symbols, and signal words in this document highlight different levels of risk.

### Caution

#### **Using Frame Shot Plus in Humid Environments with Condensation**

When moving the device and its accessories from a cool to a warm location, or when used in a damp environment, condensation may form inside the device and on electrical connections. Do not operate the device while condensation is present, as it poses a risk of electric shock and fire due to short circuits.

- Do not use the device or accessories if condensation occurs.
- After moving the device from a cool to a warm environment, allow time for the components to warm up.
- Store the device in a warmer location to reduce the risk of condensation.

### Warning

#### **Connected Cables on the Floor**

Risk of injury from tripping, falling, or slipping over connected cables.

- Always secure cables connected to the device and accessories properly.
- Install cables in a way that prevents tripping.
- Use a cable duct or secure cables with adhesive tape if necessary.
- Always disconnect cables from the device and accessories before moving them.

## 3 About Frame Shot Plus

---

Frame Shot Plus is a wonderful mix of color displays, four-way buttons, encoders and classic monochrome OLEDs. It's a perfect addition for Skaarhoj PTZ Controllers, Vision Mixing controllers and even a Mega Panel system! The color screens allow you to display a preview of a frame grabbed whilst storing presets or to generate a custom, color labels or feedback.

With Frame Shot Plus you enjoy benefits such as

- **Versatile Display Options:** Combines color and monochrome OLEDs for comprehensive control visibility.
- **Seamless Expansion:** Perfectly complements other SKAARHOJ controllers, enriching control environments.
- **User-Centric Design:** Focuses on ease of use with programmable buttons and intuitive interfaces.
- **High-End Production Ready:** Equipped for demanding settings, offering reliability and performance.
- **Adaptive Control Layout:** Customizable to match any production style or requirement.
- **Efficient Setup:** PoE eliminates extra cables, fostering a tidy and efficient workspace.
- **Durable and Dependable:** Maintains SKAARHOJ's high standards of build quality and reliability.
- **Forward-Thinking:** Designed to evolve with the changing landscape of video production technology.

### 3.1 Feature Highlights

- Perfect side car for PTZ Controller, especially PTZ View
- 8 Fully customizable buttons with dynamic color OLED screens
- 8 four-way buttons with monochrome OLED screens
- 4 rotary encoders
- Power over Ethernet (PoE) for simple setup
- Robust, durable design for professional environments
- Designed and made in Denmark

## 3.2 Intended Use

### Notice

#### Intended Use of Frame Shot Plus

All versions of Frame Shot Plus, and accessories are intended for professional use only and must be operated by skilled and trained personnel in non-domestic environments. They must not be used by inexperienced individuals without proper training.

Before use, carefully read and understand both the operating and user manuals. Use the product and its accessories solely for the purposes outlined in this document. Always follow the safety instructions and system requirements for all equipment involved.

SKAARHOJ assumes no liability for damages or modifications resulting from improper use. Modifying the product or its accessories is strictly prohibited.

## 3.3 Product Identification

The Frame Shot Plus is identified by a label located on the bottom of the device. This label contains important information such as certification marks, product code, and the serial number. Ensure this label remains intact for future reference and support.

## 3.4 Environmental Conditions

The Frame Shot Plus must be used and stored under specific environmental conditions. Before commissioning and operation, ensure the following conditions are met:

<b>Operating Temperature</b>	0° C to +40° C / +32° F to +104° F
<b>Storage Temperature</b>	-20° C to +45° C / -4° F to +113° F
<b>Humidity</b>	90% RH, non-condensing, from -20° C to +45° C

## 3.5 Technical Data and Dimensions

### 3.5.1 Standard Connections

On most SKAARHOJ products, you will find the following cable connections on the backside:

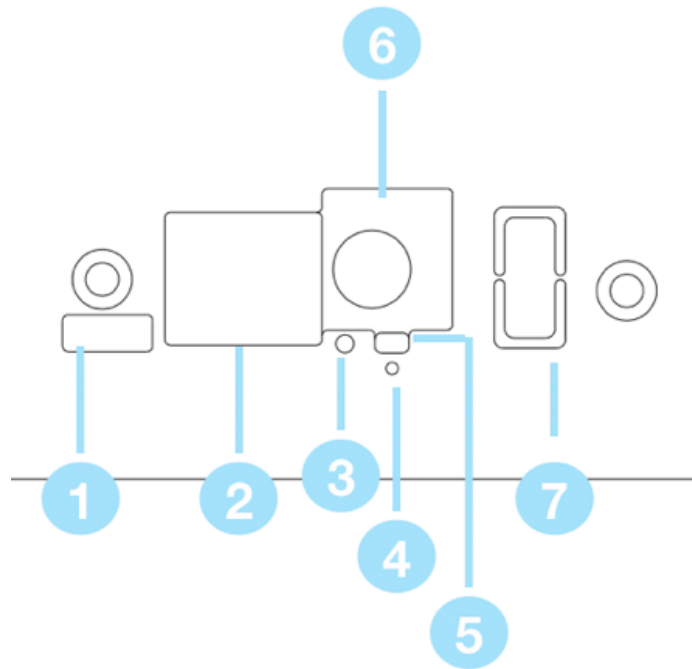

- **1:** Micro USB Port for serial communication with SKAARHOJ Firmware Updater
- **2:** IP Network RJ45 Port for IP control and 5W-15W PoE (+)/PoE Standard: IEEE 802.3af/t
- **3:** Status LED for monitoring and debugging
- **4:** Not used on Blue Pill Inside products.
- **5:** Config Button. Used to enable WiFi Access Point. See [WiFi Access Point](#) section
- **6:** 12V DC Power Supply for connection to the supplied DC power adaptor. Center is positive.
- **7:** USB-A Port. Only available on some models for attachment of accessories.

#### Notice

- Use only shielded Cat6 (STP) cables for Ethernet connections.
- Ensure that your Ethernet switch is properly connected to a protective earth ground.
- All cables, except Ethernet and GPI cables, must be shorter than 3 meters.
- If applicable: The USB-A port's power is not included in the product's maximum power rating. If near maximum load, use a powered USB hub to prevent the USB-A port from impacting the overall power budget.

### 3.5.2 Functional Earth

For EMC and ESD immunity, the enclosure must be connected to functional earth. Operation without this connection is outside the intended operating conditions and may result in degraded performance. While grounding through a shielded Ethernet cable connected to a properly grounded switch may be sufficient in some installations, the unit is tested for compliance using a dedicated grounding conductor attached to the grounding screw located above the Micro-USB port.

Connect the functional earth terminal on the enclosure to a suitable earth point using a short, low-impedance conductor (minimum 0.75 mm<sup>2</sup> / 18 AWG).

### 3.5.3 Technical Drawing

Figure 1 presents a detailed technical drawing of Frame Shot Plus, highlighting key dimensions and design elements.

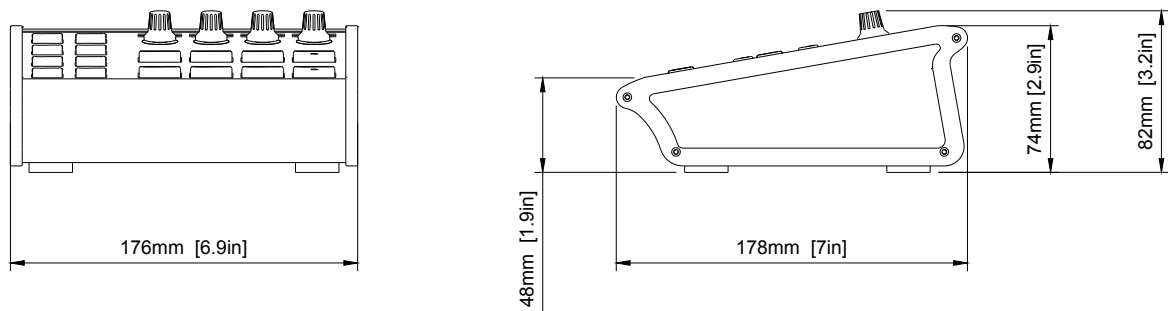

Figure 1: Technical drawing of Frame Shot Plus with key dimensions and layout details.

### 3.5.4 Technical Data

Technical data for Frame Shot Plus are presented in Table 1.

### 3.5.5 Hardware Components

The hardware components of Frame Shot Plus, along with their component IDs (Hwc ID), are shown in Figure 2.

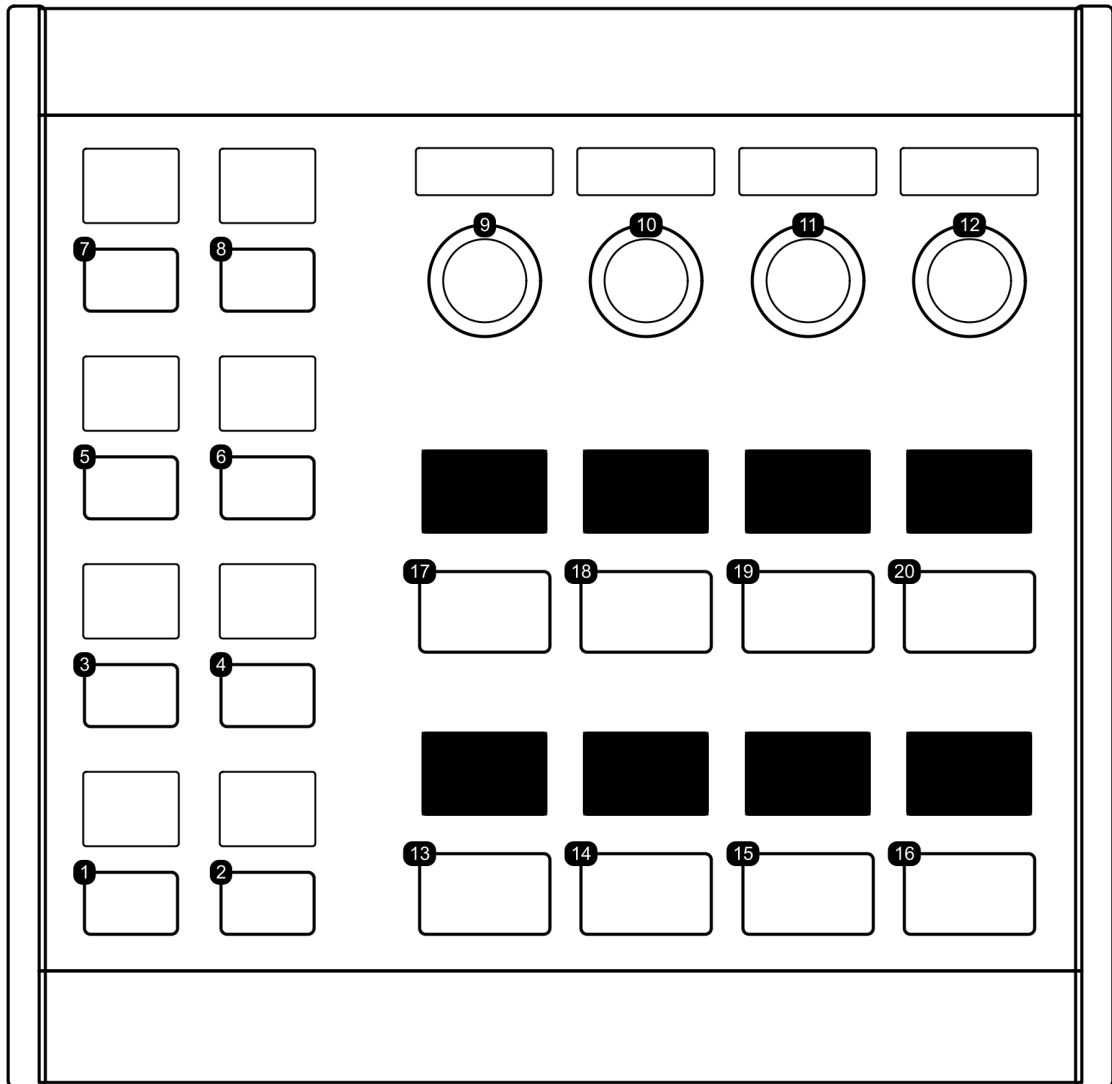

Figure 2: Diagram of hardware components for Frame Shot Plus with component IDs (HWc ID)

Hardware Specifications	
<b>Component Highlights</b>	8 Color OLED Displays
<b>Buttons</b>	Elastomer Four-Way Button (x16)
<b>Encoders</b>	Encoder (x4)
<b>Programmable OLED Tiles</b>	64x48 pixels (x8); 112x32 pixels (x4); 96x64 pixels, color (x8)
Connectivity	
<b>Networking</b>	1G Ethernet w/Power over Ethernet (PoE IEEE802.3af/t)
<b>Power Supply</b>	12V DC Jack 5.5mm x 2.1mm x 10mm Center Positive PoE IEEE802.3af/t
<b>Service Port</b>	Micro USB for setting manual IP
<b>Peripherals</b>	USB-A 2.0 (500 mA) for Stream Deck, X-keys, additional networking adapters, frame grabbers etc.
Software	
<b>Platform</b>	Blue Pill (Reactor, Device Cores, skaarOS Linux)
<b>Licenses</b>	Full Reactor and Device Core licenses included
Physical and Shipping	
<b>Product Weight</b>	1000 g
<b>Shipping Box Weight</b>	1632 g
<b>Country of Origin</b>	Denmark

Table 1: Detailed specifications and technical characteristics for Frame Shot Plus

## 3.6 Scope of Delivery and Warranty

### Notice

#### Important Information:

The packaging materials are recyclable. To contribute to environmental sustainability, please dispose of the packaging at a certified recycling facility. Ensure that all storage, shipping, and disposal comply with local regulations. SKAARHOJ assumes no responsibility for any consequences arising from improper storage, shipping, or disposal of the product.

Upon receiving the delivery, carefully inspect the package and its contents for any signs of damage or missing components. Do not accept the delivery if the package is damaged or incomplete. The package should contain the following items:

- (This Product)
- 12V Power Supply: Manufacturer: PHIHONG, Model Name: PSA15R-120P, Output: 12V/1.25A, Cable Length: 1.5m, Adapter type: EU, GB, US, AU depending on shipping country, DC Output Connector: 5.5mm x 2.1mm x 10mm Center Positive
- Getting Started Guide

For details regarding the warranty, please contact your local SKAARHOJ Service Partner. SKAARHOJ is not liable for any issues arising from improper shipping, misuse, or the use of unauthorized third-party products.

### 3.6.1 Recommended Accessories

- Ethernet Cable: Cat 6 S/FTP or better

## 3.7 Certification and Safety Standards

### 3.7.1 EU Declaration of Conformity



<b>Brand Name</b>	SKAARHOJ
<b>Product Description</b>	Universal Control Panel Frame Shot Plus

### 3.7.2 Regulatory Compliance Information

#### United States — FCC

This device complies with Part 15 of the FCC Rules. Operation is subject to the following two conditions: (1) this device may not cause harmful interference, and (2) this device must accept any interference received, including interference that may cause undesired operation.

This equipment has been tested and found to comply with the limits for a Class A digital device, pursuant to Part 15 of the FCC Rules. These limits are designed to provide reasonable protection against harmful interference when the equipment is operated in a commercial environment. This equipment generates, uses, and can radiate radio frequency energy and, if not installed and used in accordance with the instruction manual, may cause harmful interference to radio communications. Operation of this equipment in a residential area is likely to cause harmful interference in which case the user will be required to correct the interference at his own expense.

Contains FCC ID: 2ABCB-RPIRMO

Changes or modifications not expressly approved by SKAARHOJ ApS could void the user's authority to operate the equipment.

#### FCC RF Exposure Statement

This equipment complies with FCC radiation exposure limits set forth for an uncontrolled environment. This equipment should be installed and operated with a minimum distance of 20 cm between the radiator and your body.

#### Canada — ICES-003 / RSS

This Class A digital apparatus complies with Canadian ICES-003.

Cet appareil numérique de la classe A est conforme à la norme NMB-003 du Canada.

This device contains licence-exempt transmitter(s)/receiver(s) that comply with Innovation, Science and Economic Development Canada's licence-exempt RSS(s). Operation is subject to the following two

conditions: (1) this device may not cause interference, and (2) this device must accept any interference, including interference that may cause undesired operation of the device.

L'émetteur/récepteur exempt de licence contenu dans le présent appareil est conforme aux CNR d'Innovation, Sciences et Développement économique Canada applicables aux appareils radio exempts de licence. L'exploitation est autorisée aux deux conditions suivantes : (1) l'appareil ne doit pas produire de brouillage, et (2) l'utilisateur de l'appareil doit accepter tout brouillage radioélectrique subi, même si le brouillage est susceptible d'en compromettre le fonctionnement.

Contains IC: 20953-RPIRMO

### **Canada RF Exposure Statement**

This equipment complies with ISED radiation exposure limits set forth for an uncontrolled environment. This equipment should be installed and operated with a minimum distance of 20 cm between the radiator and your body.

Cet équipement est conforme aux limites d'exposition aux rayonnements ISED établies pour un environnement non contrôlé. Cet équipement doit être installé et utilisé avec un minimum de 20 cm de distance entre la source de rayonnement et votre corps.

### **European Union**

This product is CE marked in accordance with the applicable European Directives including the Radio Equipment Directive (RED) 2014/53/EU. A copy of the EU Declaration of Conformity is available upon request from SKAARHOJ ApS, Rosenkæret 11C, DK-2860 Søborg, Denmark.

### **Disposal Information**

This product is subject to the Waste Electrical and Electronic Equipment (WEEE) Directive. Dispose of this product according to local regulations. Do not dispose of with household waste.

## 4 Getting Started

---

This chapter provides a basic guide for setting up the Frame Shot Plus. The steps apply to most SKAARHOJ controllers and are therefore described in general terms.

The basic setup involves:

- Powering on the Frame Shot Plus and accessing it via its IP address
- Discovering and adding devices to be controlled
- Selecting a default configuration

The SKAARHOJ Blue Pill platform enables efficient configuration and control, storing all settings locally within the device. Online communication is only required for software updates or installation of new device cores. All configuration changes can be made over the local network with a web browser.

### 4.1 Network Requirements

Frame Shot Plus is equipped with a 1 GBit network interface and support 5W-15W PoE (IEEE 802.3af/t) or 12V DC power. Ensure the Frame Shot Plus and client device are on the same subnet (e.g., 192.168.10.\*). If multiple SKAARHOJ units are connected to the network, each device should have a unique IP address.

#### Caution

**Power over Ethernet (PoE) Specifications** SKAARHOJ controllers use the industry standard PoE (5W-15W, IEEE 802.3af/t). Note that non-standard PoE types, such as certain 24V Ubiquiti models, are incompatible with SKAARHOJ devices. Make sure the PoE switch or injector supports this standard to ensure reliable operation.

#### 4.1.1 Network Layout

We recommend connecting SKAARHOJ Blue Pill controllers to professional PoE network switches, such as the NetGear M4250-series, which efficiently handle AV network traffic. An example network layout for a SKAARHOJ control panel and connected devices, such as a camera, is shown below.

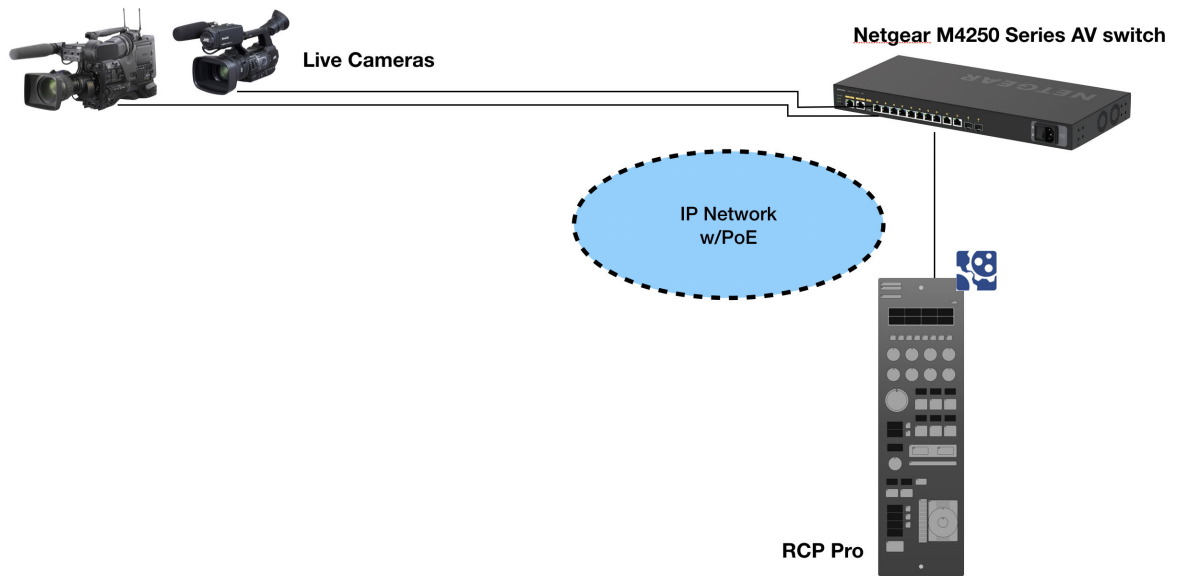

## 4.2 Accessing Frame Shot Plus

### 4.2.1 DHCP or Static IP

You can access the Frame Shot Plus' s user interface through its IP address using any web browser. The IP address is shown on one of the displays after it is connected to the network via Power over Ethernet (PoE) or through a network connection and a power supply (5V Micro USB).

By default, the Frame Shot Plus will attempt to obtain an IP address via DHCP. If DHCP is unavailable, the device will automatically use the fallback IP address 192.168.10.99 after some time.



Figure 3: IP address shown for a SKAARHOJ controller.

To access the interface, enter the IP address into the browser's address bar. You will be prompted to enter a username and password. The default credentials are:

- **Username:** admin
- **Password:** skaarhoj

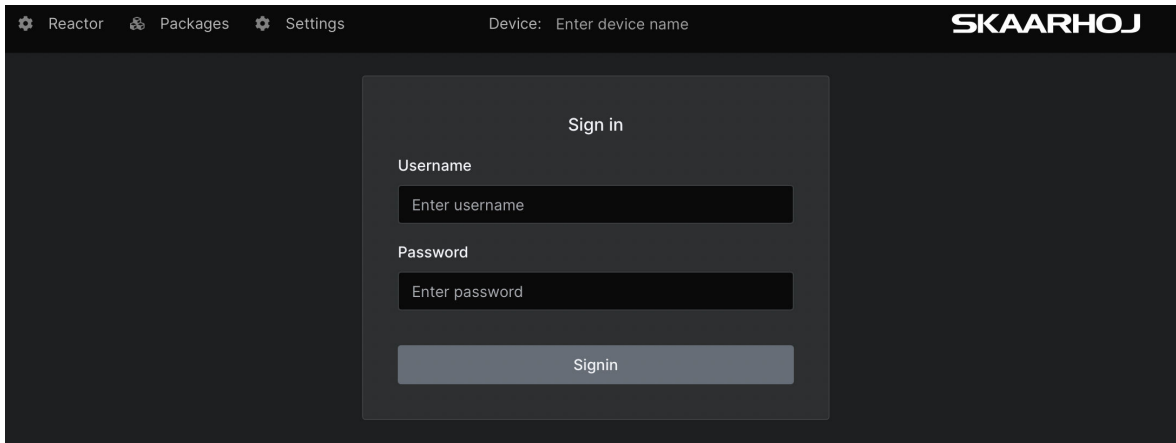

## 4.2.2 Wi-Fi Access Point

If the Frame Shot Plus does not display an IP address, you can access its web interface by enabling the internal Wi-Fi access point.

To activate the Wi-Fi access point, press and hold the config button (located next to the Ethernet port) for approximately 3 seconds. Use a flat tool, such as a paperclip or small screwdriver. When released, the access point will activate, and the LED will turn purple. The Frame Shot Plus's Wi-Fi network will then appear in your Wi-Fi list as SKAARHOJ-XXXXXX, where "XXXXXX" is the Frame Shot Plus's serial number.

The default Wi-Fi password is **skaarhoj**

After connecting to the Wi-Fi network, access the Frame Shot Plus web interface by entering the IP address 192.168.4.1 into the browser's address bar.

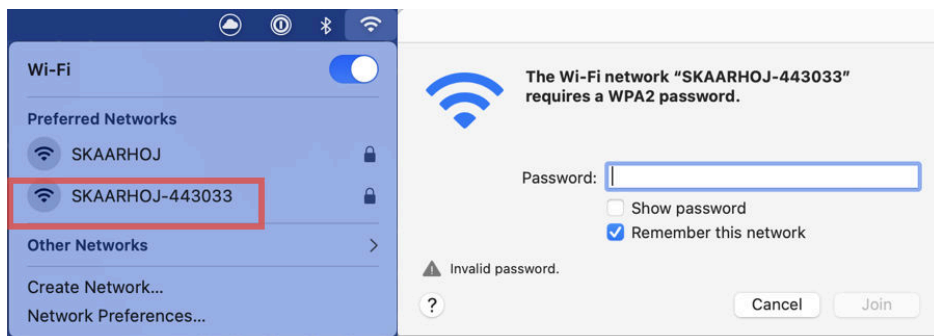

Once you access the Frame Shot Plus interface, navigate to **System Menu > System** to set a static IP address. After saving, the new IP address will display on the Frame Shot Plus's screen. You may need to reboot or power cycle the Frame Shot Plus to apply the new IP address.

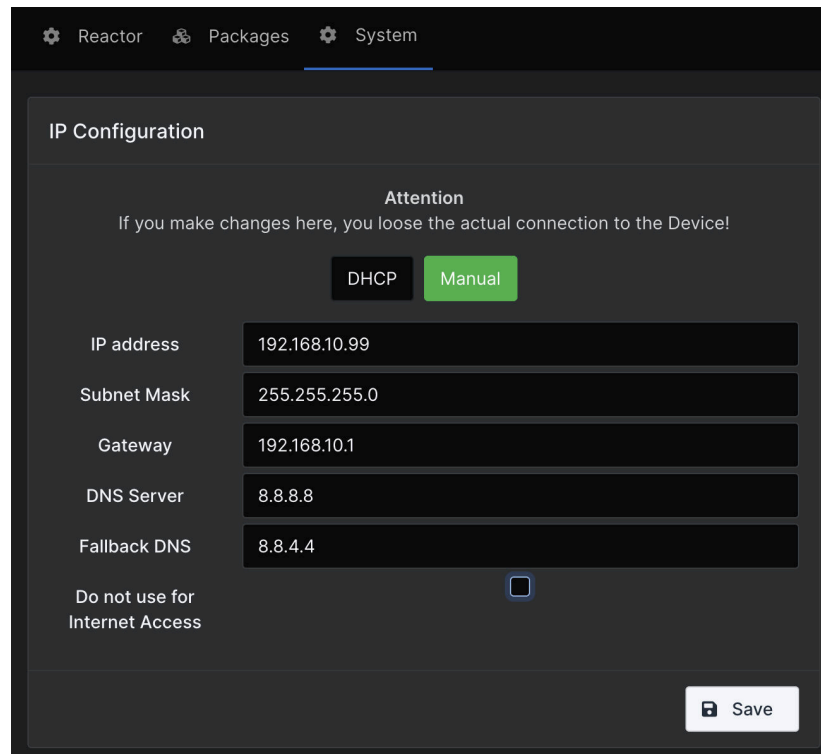

The screenshot shows the 'System' menu with 'Reactor', 'Packages', and 'System' options. The 'System' menu is selected, leading to the 'IP Configuration' page. At the top, there is an 'Attention' warning: 'If you make changes here, you loose the actual connection to the Device!'. Below this, there are two buttons: 'DHCP' and 'Manual'. The 'Manual' button is highlighted in green. The configuration fields are as follows:

Field	Value
IP address	192.168.10.99
Subnet Mask	255.255.255.0
Gateway	192.168.10.1
DNS Server	8.8.8.8
Fallback DNS	8.8.4.4

Below the fields, there is a checkbox labeled 'Do not use for Internet Access' which is currently unchecked. At the bottom right, there is a 'Save' button.

### 4.2.3 Link from SKAARHOJ Firmware Updater

If the SKAARHOJ Firmware Updater is open on a computer on the same subnet as the Frame Shot Plus, the device should appear in the updater's device list. To open the web interface directly, click on "Configure" next to the panel's information. The Frame Shot Plus does not need to be connected via USB for this feature.

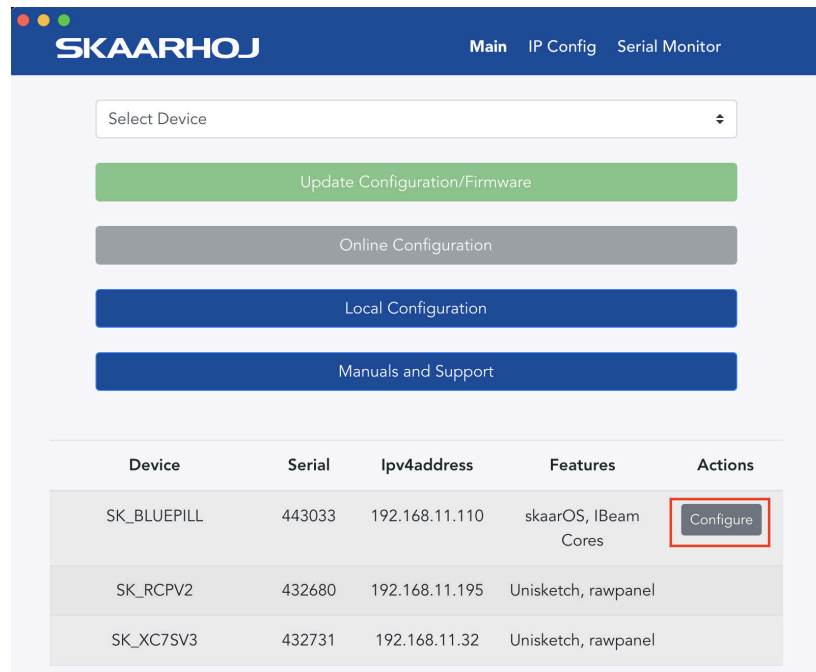

The screenshot shows the SKAARHOJ web interface. At the top, there is a navigation bar with the SKAARHOJ logo and three tabs: 'Main', 'IP Config', and 'Serial Monitor'. Below the navigation bar is a 'Select Device' dropdown menu. Underneath are four buttons: 'Update Configuration/Firmware' (green), 'Online Configuration' (grey), 'Local Configuration' (blue), and 'Manuals and Support' (blue). At the bottom, there is a table with the following data:

Device	Serial	Ipv4address	Features	Actions
SK_BLUEPILL	443033	192.168.11.110	skaarOS, IBeam Cores	Configure
SK_RCPV2	432680	192.168.11.195	Unisketch, rawpanel	
SK_XC7SV3	432731	192.168.11.32	Unisketch, rawpanel	

#### 4.2.4 SKAARHOJ Firmware Updater and Micro USB

If the network is not available, you can set the IP address using a Micro USB cable. Connect the Frame Shot Plus to your computer, where it will appear in the “Select Device” dropdown of the Firmware Updater. From there, go to the “IP Config” tab to set the IP address.



The screenshot shows the SKAARHOJ web interface with the 'IP Config' tab selected. The 'Select Device' dropdown menu is open, showing the device path '/dev/tty.usbmodem4430361 (SKAARHOJ)'.

For example, on MacOS, the Frame Shot Plus might appear as “/dev/tty.usbmodem4430361”. Clicking “IP Config” opens the IP setup page.



The screenshot shows the 'IP Configuration' page in the SKAARHOJ web application. The page has a dark blue header with the SKAARHOJ logo and navigation links for 'Main', 'IP Config', and 'Serial Monitor'. The main content area is light blue and contains the following fields:

- Use DHCP:** A checkbox labeled 'Enable' which is currently unchecked.
- IP Address:** A text input field containing '10.11.12.13' with a green checkmark to its right.
- Subnet Mask:** A text input field containing '255.255.255.0' with a green checkmark to its right.
- Gateway:** A text input field containing '10.11.12.0' with a green checkmark to its right.
- DNS Server:** A text input field containing '8.8.8.8' with a green checkmark to its right.

Below these fields is a section titled 'Device Cores' which contains two buttons: a grey 'Cancel' button and a green 'Save Settings' button.

If a warning appears, click “Submit” and reboot the Frame Shot Plus to apply the settings.

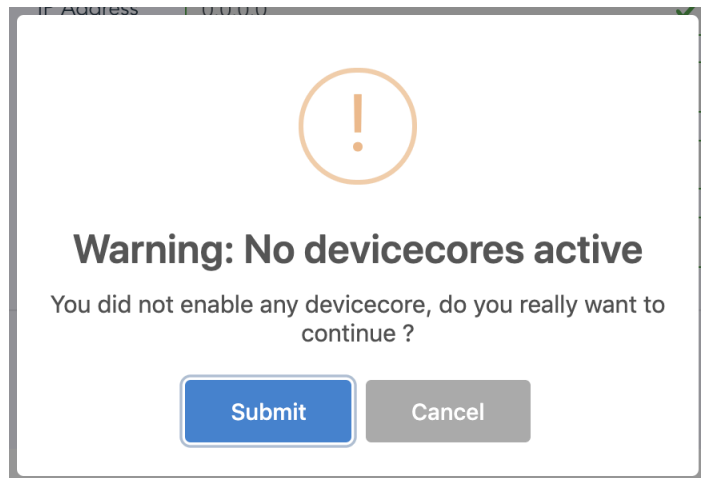

### 4.3 Selecting Default Configuration

The Frame Shot Plus’s function is determined by its configuration, which is selected through a drop down on the Home Screen. In most cases, the **Generic** configuration is sufficient. However, for specific panel and device combinations, dedicated configurations may be available.

To select the default configuration, use the dropdown menu next to the panel.

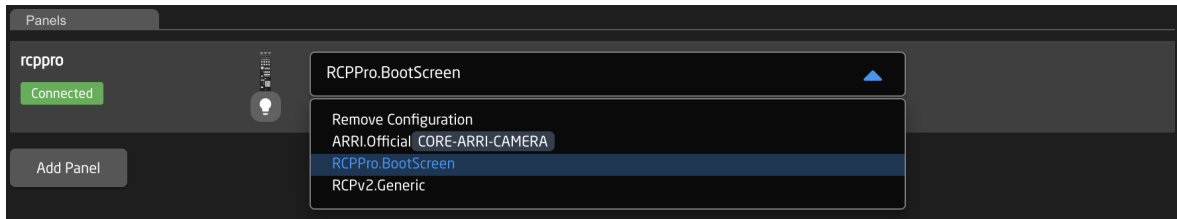

## 4.4 Adding Devices

There are two main ways to add devices to a new Frame Shot Plus setup: **Auto Discover** and **Manual Add**.

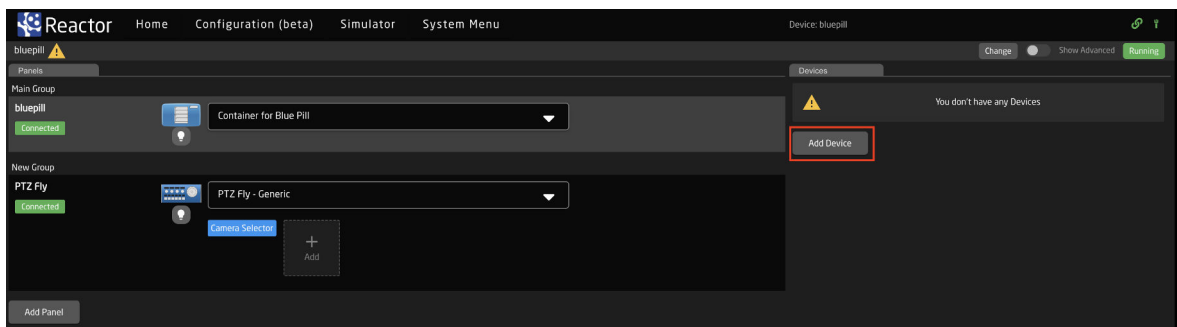

### 4.4.1 Auto Discover

The Auto Discover feature scans the network for compatible devices using mDNS and other discovery methods. While not all devices are discoverable this way, those that are can be added to the Frame Shot Plus's device list with a single click. After adding a device via Auto Discover, you may still need to input certain details to establish connectivity. See Section [4.4.3](#) for further setup information.

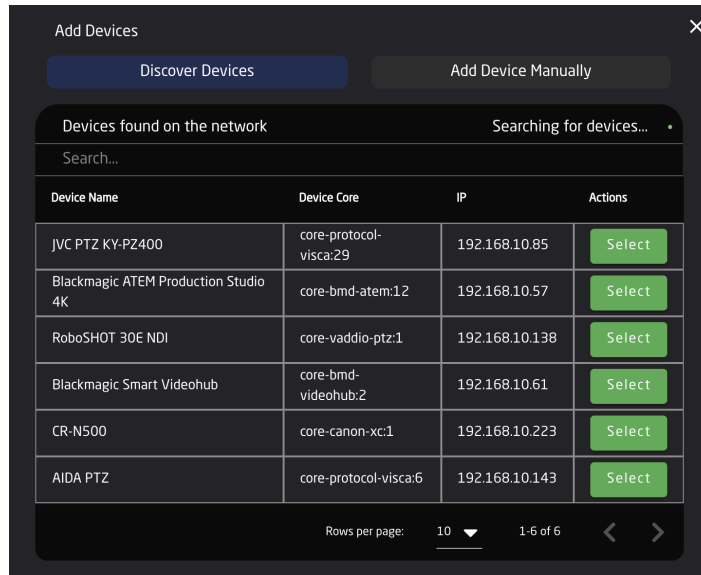

To select multiple devices, hold **SHIFT** and click the green **Select** button.

#### 4.4.2 Manual Add

If a device is not discoverable, it can be added manually. Simply look up the device model in the list of supported devices and enter the IP address along with any other required details. See Section 4.4.3 for further setup.

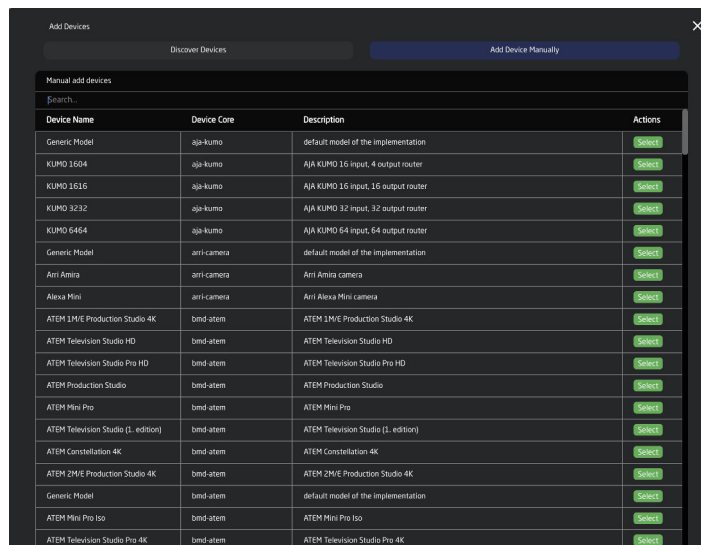

To add multiple devices manually, hold **SHIFT** and click the green **Add Device** button.

### 4.4.3 Device Details

Each device's status is displayed in the overview on the Home screen.

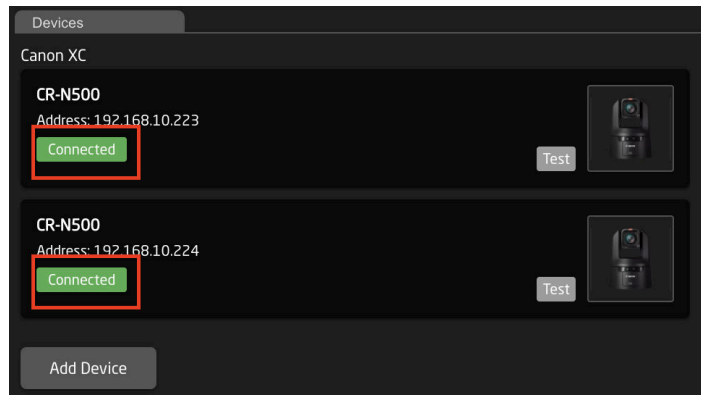

Clicking on a device's name in the **Devices** section opens the device details. Here, you can modify the device's **Name**, **ID**, and **Active Status**. By default, the device name matches the model, the ID is assigned in sequence, and the status is set to active. A device must be active to function.

When applicable, you can enter a specific username and password for device connectivity. If these fields are left blank, the Frame Shot Plus will attempt to connect using the device's default credentials.

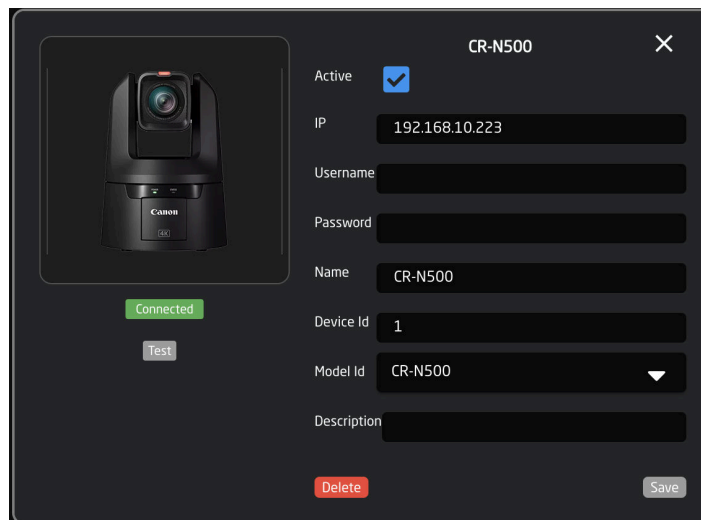

### 4.4.4 Populating Settings Tables

The final step in configuring the Frame Shot Plus is filling in any **Settings Tables**. These tables are available based on the selected configuration and allow you to specify details such as specific cameras for a PTZ controller or input/output settings for a video switcher. Settings tables are most commonly used for PTZ cameras and routing panels, though they may also apply to other configurations.

Once populated, the settings will auto-save and instantly appear on the panel's displays, enabling functionality.

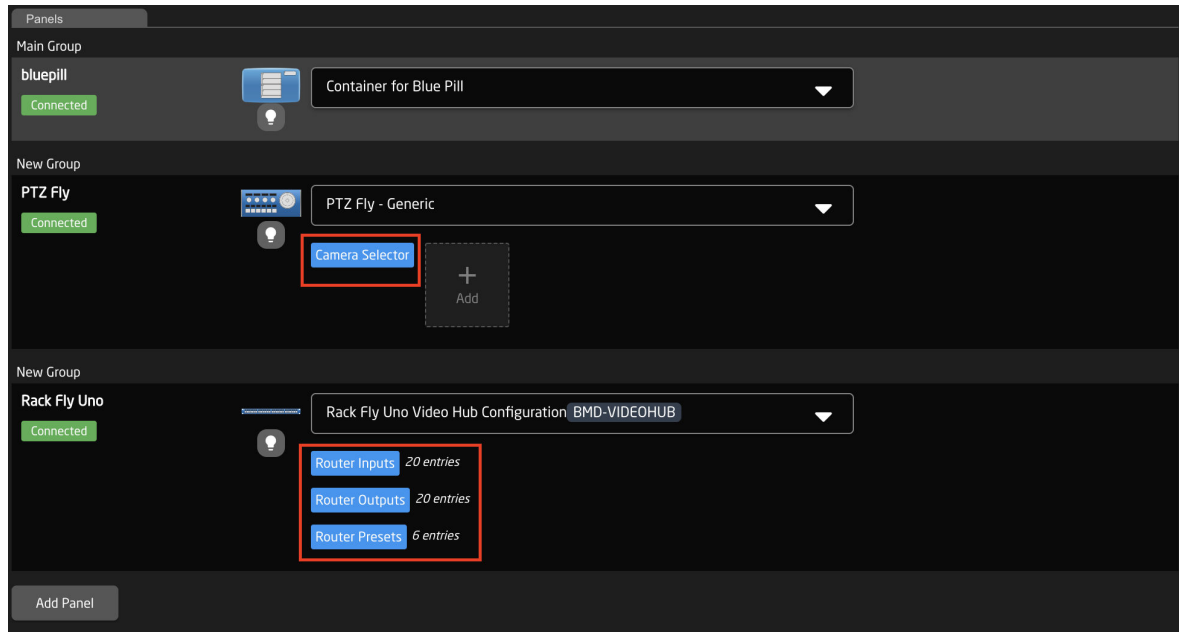

For example, the Camera Selector table enables you to configure specific cameras, adjust their order on the selector row, and assign display names. The columns are described in Table 2.

Constable Set

Name: Camera Selector Description: This sets up the cameras using Standard Class configurations.

Drag	Mute	Binding	Device Number:	Camera name:	Use device configuration:	Configuration for Iris/Master black channels:	Tally Index:	FrameLink Window:
	<input type="checkbox"/>	CR-N500	1	CR-N500	SKAARHOJ Devices.Canon-XC.StdClass.basic	SKAARHOJ Devices.Canon-XC.IrisChannel		
	<input type="checkbox"/>	CR-N500	2	CR-N500	SKAARHOJ Devices.Canon-XC.StdClass.basic	SKAARHOJ Devices.Canon-XC.IrisChannel		

NEW

The Router Input and Output tables allow configuration of input/output settings, custom display names, and button colors. The columns are described in Table 3.

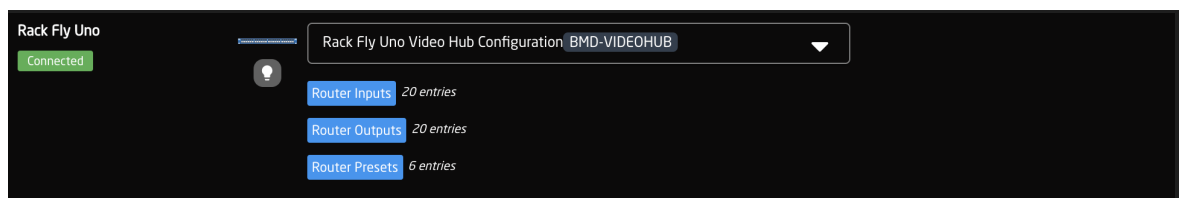

Column	Description
<b>Drag</b>	Rearranges camera order; right-clicking allows row deletion.
<b>Mute</b>	Disables access to specific cameras or leaves a blank spot.
<b>Binding</b>	Selects a connected camera.
<b>Camera Name</b>	Customizable display name, character limit varies by display size.
<b>Device Number</b>	Links to the specific device; auto-populates with camera selection in Binding.
<b>Link Selector</b>	Assigns protocol configuration for the camera.
<b>Channel Link</b>	Selects protocol for Iris/Master Black control (not available in all classes).
<b>Tally Index</b>	Connects to the corresponding tally source device (optional).
<b>Route Index</b>	Connects with a routing device (optional).
<b>FrameLink Window</b>	Associates with FrameLink device core (optional).

Table 2: Columns in the Camera Selector settings table.

Column	Description
<b>Drag</b>	Rearranges input/output order; right-clicking allows row deletion.
<b>Mute</b>	Disables access to specific inputs/outputs or leaves a blank spot.
<b>Output Number/Input Number</b>	Connects to a specific input/output, determined by the router.
<b>Alternative Label</b>	Customizable display name; character limit varies by display size.
<b>Color</b>	Sets button feedback color; options include OFF, WHITE, WARM, RED, ROSE, PINK, PURPLE, AMBER, YELLOW, DARKBLUE, BLUE, ICE, CYAN, SPRING, GREEN, MINT. Use uppercase format with no spaces.

Table 3: Columns in the Router Input and Output settings tables.

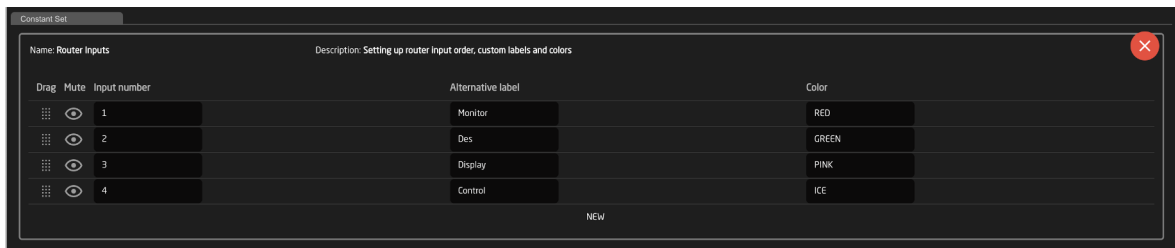

## 4.5 Beyond Default Configurations

SKAARHOJ controllers are versatile across models, allowing for default configurations and additional device integration.

Given the wide range of configurations possible, documenting each is impractical. For setup guidance with specific devices on your SKAARHOJ panel, please refer to the resources available on our [wiki pages](#).

To further customize your Frame Shot Plus, explore the advanced options in the **Configuration Tab** in Reactor. For detailed guidance, we recommend our online tutorials and additional resources at [wiki.skaarhoj.com](http://wiki.skaarhoj.com).

## 5 Service

---

### 5.1 Troubleshooting

For troubleshooting tips, please refer to our online Wiki:

<https://wiki.skaarhoj.com/books/blue-pill-reactor/chapter/troubleshooting>

### 5.2 Cleaning

Proper cleaning and maintenance of your Frame Shot Plus are critical to ensuring its durability and optimal performance. Regular cleaning, when done with care and the right materials, will help maintain the device in excellent working condition. On the other hand, improper cleaning techniques or the use of harsh chemicals can lead to permanent damage to surfaces, connectors, and labels. To prevent wear and tear, it is important to adhere to the cleaning recommendations outlined in this section.

#### Notice

##### Proper Cleaning of Frame Shot Plus

To avoid surface damage, follow these guidelines:

- **Disconnect all accessories and cables** before cleaning.
- **Only use the recommended cleaning agents** listed in this section.
- **Avoid harsh chemicals** like Methanol, Acetone, Benzene, or acids. These substances may damage labels, paint, and polished surfaces.
- **Keep connectors dry** —do not moisten connectors or expose them to cleaning liquids.
- **Avoid touching connector pins** directly while cleaning.
- **Air-blow dust from connectors** before wiping them. Use deionized air if static charge is present.
- **Do not use compressed air** on the housing, as it can push dust into the device.

#### Recommended Cleaning Agents:

- Water
- Glass Cleaner
- Isopropyl Alcohol

To maintain the longevity and optimal performance of your Frame Shot Plus, it is essential to follow proper cleaning guidelines. Different areas of the device require specific cleaning methods to avoid

damage to sensitive components. The following table outlines the recommended cleaning procedures for key areas of the device.

Area	Recommended Cleaning Procedure
<b>Housing</b>	Wipe the housing and external accessories with a soft, lint-free cloth and a mild cleaner like water or glass cleaner.  When necessary, use isopropyl alcohol to remove tough residues, such as adhesive or dirt buildup.
<b>Narrow spaces and gaps</b>	Use a manual air blower or a soft brush to gently remove dust from gaps and tight spaces. For delicate areas, cotton swabs may also be used.

Table 4: Proper cleaning methods for Frame Shot Plus

By following these cleaning instructions, you can avoid damaging your device and its components. Routine maintenance will keep your Frame Shot Plus in top condition and reduce the likelihood of damage that could lead to costly repairs or replacements.

## 5.3 Repair

In addition to proper cleaning, it is also important to be cautious when it comes to repairs. Performing repairs without the necessary expertise can result in personal injury and may further damage the device.

### Warning

#### Repairs by Untrained Personnel

Attempting to repair the device without proper training can lead to injury and product damage:

- **Only perform maintenance tasks** described in this manual.
- **Do not attempt repairs yourself** —all repairs must be carried out by authorized SKAARHOJ service partners.
- **Warranty is void** if unauthorized repairs are attempted.

Repairs and maintenance should always be conducted by professionals trained to handle the Frame Shot Plus. If you encounter any issues requiring repair, we highly recommend contacting SKAARHOJ's authorized service partners. Unauthorized repairs may void the warranty, cause further damage, and pose significant safety risks.

To keep your Frame Shot Plus functioning optimally, always refer to this manual for proper cleaning and repair procedures. For any work beyond the scope of this manual, please contact SKAARHOJ Support team for assistance.

## 5.4 Disposal

### Notice

#### Disposal of the Product

You can return the product at your own expense to the manufacturer, SKAARHOJ ApS, for disposal. Always follow local guidelines and laws for proper disposal.

Proper disposal of electronic equipment is essential to reduce environmental impact and ensure that hazardous materials are handled safely. Different countries may have specific laws and guidelines regarding electronic waste disposal. It is important to familiarize yourself with these rules to ensure compliance and minimize risks to both health and the environment.

When disposing of third-party accessories, always consult the instructions provided by the relevant manufacturers to ensure safe and compliant disposal practices.

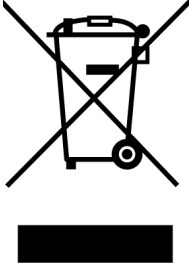

**This product falls within the scope of Directive 2012/19 / EU OF THE EUROPEAN PARLIAMENT AND OF THE COUNCIL of June 4, 2012 on waste electrical and electronic equipment (WEEE II).**

Accordingly, this product must not be disposed of with household waste. Always adhere to country-specific disposal rules and ensure proper recycling or disposal through authorized facilities.

In addition to the general guidelines provided above, the product must always be disposed of in accordance with local electronic waste regulations. The WEEE Directive sets the framework for the handling of waste electrical and electronic equipment across EU member states. It ensures that electronics are collected and treated separately from household waste to minimize environmental harm.

## 5.5 Transportation and Storage

### Notice

#### Proper Handling of Frame Shot Plus

To avoid the risk of product damage:

- Follow the recommended environmental conditions at all times.
- Use an appropriate case for transporting the product and its accessories.
- Adhere to the transport and storage guidelines outlined in this section.

Ensuring proper transportation and storage of your Frame Shot Plus is critical to maintaining its performance and longevity. Mishandling the device or its accessories can lead to damage. Please follow these guidelines to protect your equipment during transportation and storage.

**Transportation Guidelines:**

- Detach all accessories from the product before transport.
- Always transport the product in a protective case designed for its dimensions.
- Avoid exposing the product to strong shocks or impacts during transport.
- Keep the product within the recommended temperature range.

**Storage Guidelines:**

- Remove all accessories before storing.
- Disconnect all cables and power sources from the product.
- Store the product in a protective case.
- Keep the product within the recommended temperature range.
- Avoid storing the product in environments exposed to extreme temperatures, direct sunlight, high humidity, excessive vibration, dust, or strong magnetic fields.

## 5.6 SKAARHOJ Service Contacts

For any inquiries, technical support, or service requests regarding your Frame Shot Plus, please reach out to our support team. Our dedicated professionals are ready to assist you with troubleshooting, repairs, and general product information. You can find the contact details for SKAARHOJ below.

**SKAARHOJ ApS**

Rosenkaeret 11C  
DK-2860 Soeborg  
Denmark  
Email: [support@skaarhoj.com](mailto:support@skaarhoj.com)  
Website: [www.skaarhoj.com](http://www.skaarhoj.com)

**SKAARHOJ Inc**

2600 W Olive Avenue Suite 500  
Burbank, CA 91505  
USA  
Email: [support@skaarhoj.com](mailto:support@skaarhoj.com)  
Website: [www.skaarhoj.com](http://www.skaarhoj.com)

## 6 Notes

---