

RCP Pro

User Manual

February 22, 2026

SKUs: RCP-PRO-V2B-BK

Language: English

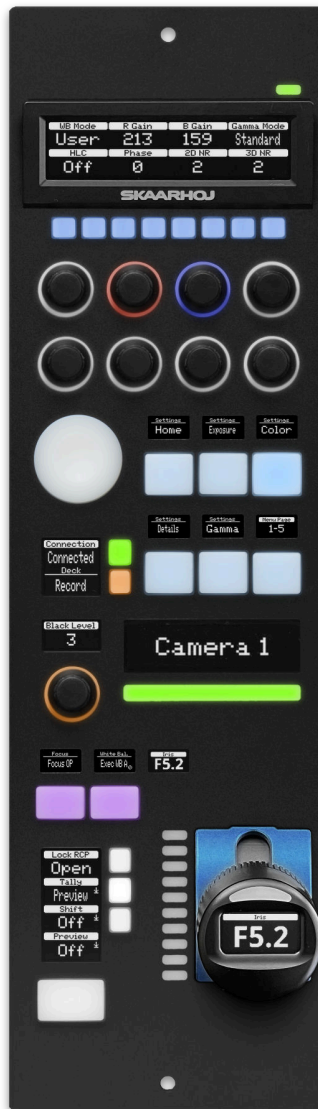

I Disclaimer

Before using this product, please read and fully understand all instructions provided. This product is classified as Class A equipment and is intended for use by commercial customers only. It is not suitable for residential use and may cause interference in residential environments.

For the most up-to-date specifications, refer to the latest SKAARHOJ data sheets or publications. Availability of products and types may vary by country —please check with a SKAARHOJ sales representative for details.

The information in this document is subject to change without notice. While SKAARHOJ strives to ensure the quality, reliability, and safety of its products, defects cannot be entirely ruled out. To minimize risks of damage or injury, customers must implement appropriate safety measures and follow the intended use guidelines.

SKAARHOJ and its subsidiaries disclaim any liability, warranty, or responsibility for claims, whether in contract, tort, or any other legal theory. SKAARHOJ shall not be liable for any special, direct, indirect, incidental, or consequential damages, including lost profits, revenues, or economic losses, or for third-party claims, equipment replacement, or any other damages.

SKAARHOJ does not assume liability for patent, copyright, or intellectual property infringement arising from the use of its products. No license or rights are granted under any patents or intellectual property of SKAARHOJ or third parties.

If any of the above clauses are not permitted by applicable law, they will be enforced to the maximum extent allowed.

II Imprint

© 2026 SKAARHOJ. All rights reserved.

This device contains proprietary information of SKAARHOJ and is provided under a license agreement with restrictions on use and disclosure, protected by copyright law. Reverse engineering of the hardware and software is prohibited.

No part of this publication may be distributed, reproduced, transmitted, transcribed, stored in a data retrieval system, or translated into any language in any form by any means without prior written permission from SKAARHOJ.

If you download files from our website for personal use, ensure you check for updated versions. SKAARHOJ cannot be held liable for downloaded files, as technical data is subject to change without notice.

Due to ongoing product development, the information in this document may change without notice. The information and intellectual property contained herein is confidential between SKAARHOJ and the client and remains SKAARHOJ's exclusive property. Please report any issues with the documentation in writing. SKAARHOJ does not guarantee this document is error-free.

The source language of this manual is English. Translations into other languages are derived from the English version.

For further assistance:

SKAARHOJ ApS
Rosenkaeret 11C
DK-2860 Soeborg
Denmark
Email: info@skaarhoj.com
Website: www.skaarhoj.com

II.1 Trademarks

SKAARHOJ® is a registered trademark of SKAARHOJ ApS. The following names are also trademarks of SKAARHOJ: Raw Panel™, Blue Pill™, Reactor™, UniSketch™, Device Core™, and RCP Pro™.

All other trademarks are the property of their respective owners and are acknowledged as such.

III Document Legends

This section explains the meaning of various alert levels and informational notes used throughout this document. Each label serves as a guide to indicate the level of attention required and the type of risk involved. Please review these legends carefully to ensure a clear understanding of the warnings, cautions, and helpful tips provided.

Danger

DANGER indicates an imminent hazard. Failure to avoid it will result in death or serious injury. Always follow the recommended actions to prevent this danger.

Warning

WARNING indicates a potential hazard. Failure to avoid it may result in death or serious injury. Always follow the recommended actions to prevent this risk.

Caution

CAUTION indicates a possible hazard. Failure to avoid it may result in minor or moderate injuries. Always follow the recommended actions to prevent this hazard.

Notice

NOTICE indicates a potential risk of equipment or environmental damage. Always follow the recommended actions to avoid damage.

Hint

HINT provides additional information to clarify or simplify a procedure. It is not related to safety.

Contents

I Disclaimer	1
II Imprint	2
II.1 Trademarks	2
III Document Legends	3
1 About this Document	5
2 Safety Information	6
3 About RCP Pro	7
3.1 Feature Highlights	7
3.2 Intended Use	8
3.3 Product Identification	8
3.4 Environmental Conditions	8
3.5 Technical Data and Dimensions	8
3.5.1 Standard Connections	8
3.5.2 GPI Connections	10
3.5.3 Functional Earth	10
3.5.4 Technical Drawing	10
3.5.5 Technical Data	10
3.5.6 Hardware Components	12
3.6 Important Notes on Product Usage	12
3.6.1 Fader Tuning	14
3.7 Scope of Delivery and Warranty	14
3.7.1 Recommended Accessories	14
3.8 Certification and Safety Standards	15
3.8.1 EU Declaration of Conformity	15
3.8.2 Regulatory Compliance Information	15
4 Getting Started	17
4.1 Network Requirements	17
4.1.1 Network Layout	17
4.2 Accessing RCP Pro	18

4.2.1	DHCP or Static IP	18
4.2.2	Wi-Fi Access Point	19
4.2.3	Link from SKAARHOJ Firmware Updater	20
4.2.4	SKAARHOJ Firmware Updater and Micro USB	21
4.3	Selecting Default Configuration	22
4.4	Adding Devices	23
4.4.1	Auto Discover	23
4.4.2	Manual Add	24
4.4.3	Device Details	25
4.4.4	Populating Settings Tables	25
4.5	Beyond Default Configurations	27
5	Service	28
5.1	Troubleshooting	28
5.2	Cleaning	28
5.3	Repair	29
5.4	Disposal	30
5.5	Transportation and Storage	30
5.6	SKAARHOJ Service Contacts	31
6	Notes	32

1 About this Document

This operating manual is intended for all users of the SKAARHOJ RCP Pro. It provides essential guidelines for safe and proper operation of the device. All users must read this manual before using the device for the first time to ensure correct usage.

The manual is an important part of the RCP Pro and should be kept easily accessible, close to the device for reference at any time.

For more detailed information about the device's features and functionality, please refer to additional instructions available for download at www.skaarhoj.com or request them via support@skaarhoj.com.

Ensure that the operating manual, user manual, and any other relevant documentation are stored safely for future reference and for any potential future users of the device.

For more resources and helpful information, visit the SKAARHOJ website.

SKAARHOJ offers comprehensive training courses to provide deeper insights into maximizing the potential of SKAARHOJ products.

2 Safety Information

This safety information supplements the specific operating instructions and must be strictly followed. Before operating or installing the device, read and understand all safety and operating instructions. Keep these instructions for future reference. Always follow the guidelines in this and any other documentation provided to avoid injury or damage to the device and surrounding objects.

Assembly and operation should only be performed by trained personnel familiar with the device. Use only the recommended tools, materials, and procedures outlined in this document. For other equipment, refer to the manufacturer's instructions.

Safety instructions, warning symbols, and signal words in this document highlight different levels of risk.

Caution

Using RCP Pro in Humid Environments with Condensation

When moving the device and its accessories from a cool to a warm location, or when used in a damp environment, condensation may form inside the device and on electrical connections. Do not operate the device while condensation is present, as it poses a risk of electric shock and fire due to short circuits.

- Do not use the device or accessories if condensation occurs.
- After moving the device from a cool to a warm environment, allow time for the components to warm up.
- Store the device in a warmer location to reduce the risk of condensation.

Warning

Connected Cables on the Floor

Risk of injury from tripping, falling, or slipping over connected cables.

- Always secure cables connected to the device and accessories properly.
- Install cables in a way that prevents tripping.
- Use a cable duct or secure cables with adhesive tape if necessary.
- Always disconnect cables from the device and accessories before moving them.

3 About RCP Pro

The RCP Pro is SKAARHOJ's pinnacle of camera shading controllers, integrating a novel joystick with an inbuilt Tally Light and OLED Screen to dynamically display Iris values. It boasts a large, angled screen for optimal viewability, coupled with a plethora of fully customizable knobs and buttons for unparalleled control. Elevating from the standard RCPv2, the RCP Pro offers a luxurious experience with Blue Pill Inside, ensuring compatibility with today's high-end cameras like RED, Canon, ARRI, and Panasonic Lumix. Blue Pill Inside, SKAARHOJ's cutting-edge platform, enhances control capabilities, as detailed in SKAARHOJ's informative YouTube video.

With RCP Pro you enjoy benefits such as

- Modern design, ideal for newly-built or refurbished OB trucks.
- Maintains full control functionality with a proprietary RCP Handle and OLED display.
- Compatible with a wide range of cameras via Reactor and Blue Pill cores.
- Dedicated OLED displays for each encoder provide clear, immediate feedback.
- Supports Standard and Exclusive TriClass configurations for tailored control.
- Maximizes limited spaces with its efficient design and versatile control options.
- Offers premium camera shading capabilities.

3.1 Feature Highlights

- Unique Joystick for iris adjustments and black level pedestal
- 8 buttons for camera selection and presets
- 8 encoders for shading and menu cycling
- Crisp display for monitoring of values
- Joystick pad for adjusting PTZ cameras
- Four-way buttons for shortcuts and camera settings
- Universal control of multiple 3rd party devices
- Industry-standard form factor
- User customization with Reactor Web UI
- 1G Ethernet w/Power over Ethernet (PoE IEEE802.3af/t)
- Designed and made in Denmark

3.2 Intended Use

Notice

Intended Use of RCP Pro

All versions of RCP Pro, and accessories are intended for professional use only and must be operated by skilled and trained personnel in non-domestic environments. They must not be used by inexperienced individuals without proper training.

Before use, carefully read and understand both the operating and user manuals. Use the product and its accessories solely for the purposes outlined in this document. Always follow the safety instructions and system requirements for all equipment involved.

SKAARHOJ assumes no liability for damages or modifications resulting from improper use. Modifying the product or its accessories is strictly prohibited.

3.3 Product Identification

The RCP Pro is identified by a label located on the bottom of the device. This label contains important information such as certification marks, product code, and the serial number. Ensure this label remains intact for future reference and support.

3.4 Environmental Conditions

The RCP Pro must be used and stored under specific environmental conditions. Before commissioning and operation, ensure the following conditions are met:

Operating Temperature	0° C to +40° C / +32° F to +104° F
Storage Temperature	-20° C to +45° C / -4° F to +113° F
Humidity	90% RH, non-condensing, from -20° C to +45° C

3.5 Technical Data and Dimensions

3.5.1 Standard Connections

On most SKAARHOJ products, you will find the following cable connections on the backside:

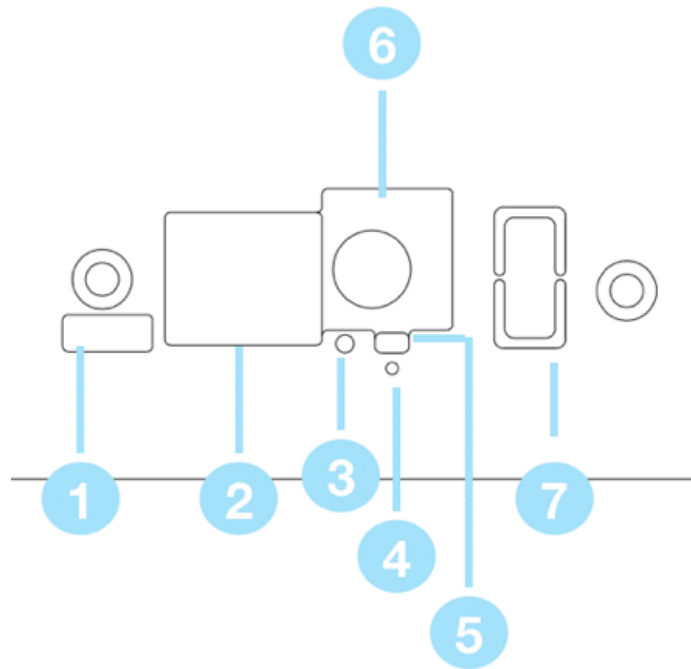

- **1:** Micro USB Port for serial communication with SKAARHOJ Firmware Updater
- **2:** IP Network RJ45 Port for IP control and 5W-15W PoE (+)/PoE Standard: IEEE 802.3af/t
- **3:** Status LED for monitoring and debugging
- **4:** Not used on Blue Pill Inside products.
- **5:** Config Button. Used to enable WiFi Access Point. See [WiFi Access Point](#) section
- **6:** 12V DC Power Supply for connection to the supplied DC power adaptor. Center is positive.
- **7:** USB-A Port. Only available on some models for attachment of accessories.

Notice

- Use only shielded Cat6 (STP) cables for Ethernet connections.
- Ensure that your Ethernet switch is properly connected to a protective earth ground.
- All cables, except Ethernet and GPI cables, must be shorter than 3 meters.
- If applicable: The USB-A port's power is not included in the product's maximum power rating. If near maximum load, use a powered USB hub to prevent the USB-A port from impacting the overall power budget.

3.5.2 GPI Connections

The RCP Pro features additional connectors for specialized functionality. The following describes the pin connections on the device connector:

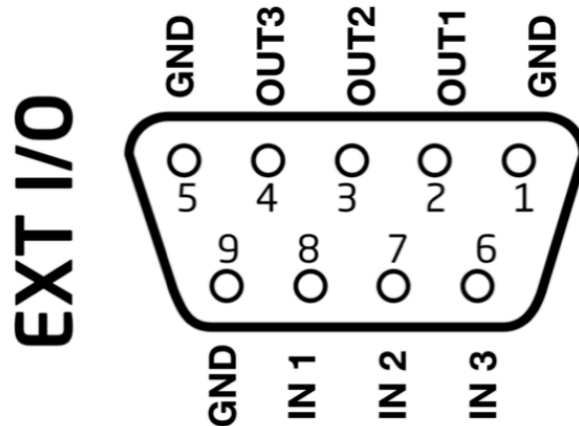

- All IN signals are activated by shorting them to GND.
- All OUT signals are shorted to GND by an internal relay when activated. Relay is rated for 30V DC / 1A max.

3.5.3 Functional Earth

For EMC and ESD immunity, the enclosure must be connected to functional earth. Operation without this connection is outside the intended operating conditions and may result in degraded performance. While grounding through a shielded Ethernet cable connected to a properly grounded switch may be sufficient in some installations, the unit is tested for compliance using a dedicated grounding conductor attached to the grounding screw located above the Micro-USB port.

Connect the functional earth terminal on the enclosure to a suitable earth point using a short, low-impedance conductor (minimum 0.75 mm² / 18 AWG).

3.5.4 Technical Drawing

Figure 1 presents a detailed technical drawing of RCP Pro, highlighting key dimensions and design elements.

3.5.5 Technical Data

Technical data for RCP Pro are presented in Table 1.

Hardware Specifications	
Component Highlights	SKAARHOJ exclusive fader handle with display, LED, pedestal ring and push function ('Sony feel') Raised Display
Buttons	Elastomer Button (x13); Elastomer Four-Way Button w/Display (x8); Elastomer Four-Way Button (x1); Joystick top button (x1)
Encoders	Encoder w/LED ring (x8); Encoder (x1); Joystick encoder (x1)
Analog Components	Elastomer Joystick, Left-Right (x1); Elastomer Joystick, Up-Down (x1); Joystick fader (x1); Opto-isolated Input (to GND) (x1)
Programmable OLED Tiles	128x64 pixels (x1); 64x64 pixels (x2); 64x32 pixels, gray (x14); 64x32 pixels (x12); 128x32 pixels (x1)
GPIs	Opto-isolated Input (to GND) (x3)
Other	OLED Display Tile (x7); (x1); LED-Bar, 10 steps (x1); Relay Output (to GND) (x3); LED (x1); LED in RCP Pro joystick (x1)
Connectivity	
Networking	1G Ethernet w/Power over Ethernet (PoE IEEE802.3af/t)
Power Supply	12V DC Jack 5.5mm x 2.1mm x 10mm Center Positive PoE IEEE802.3af/t
Service Port	Micro USB for setting manual IP
Peripherals	3 channel GPIO (3 opto-isolated inputs / 3 relay outputs)
Software	
Platform	Blue Pill (Reactor, Device Cores, skaarOS Linux)
Licenses	Full Reactor and Device Core licenses included
Physical and Shipping	
Product Weight	1289 g
Shipping Box Weight	2054 g
Country of Origin	Denmark

Table 1: Detailed specifications and technical characteristics for RCP Pro

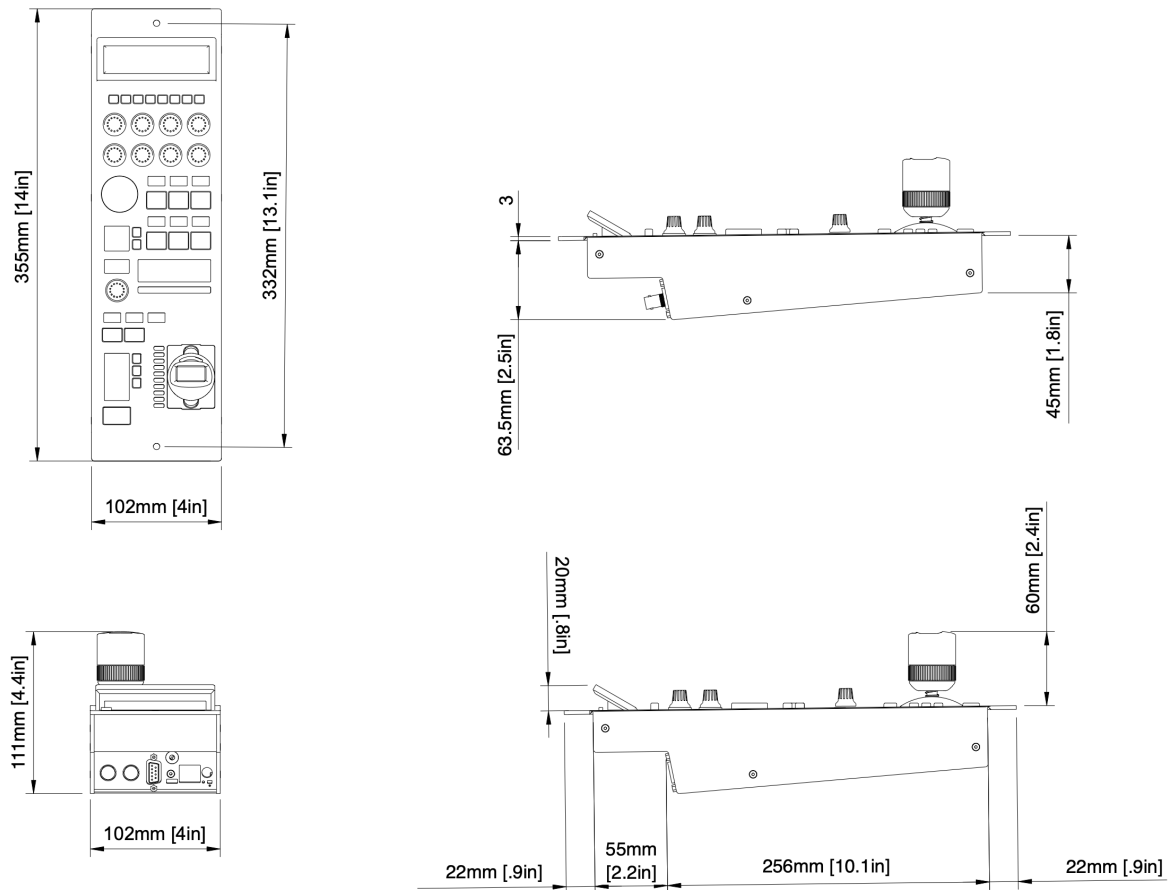

Figure 1: Technical drawing of RCP Pro with key dimensions and layout details.

3.5.6 Hardware Components

The hardware components of RCP Pro, along with their component IDs (HwC ID), are shown in Figure 2.

3.6 Important Notes on Product Usage

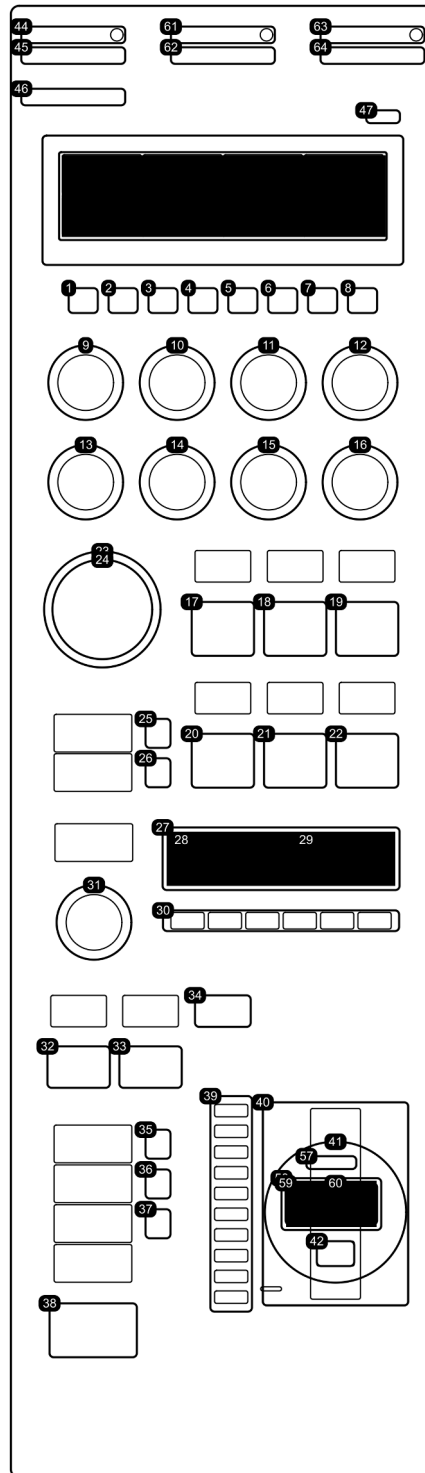

Figure 2: Diagram of hardware components for RCP Pro with component IDs (Hwc ID)

3.6.1 Fader Tuning

Hint

Your control panel includes one or more fader components, such as motorized faders, T-Bars, joystick handles, or potentiometers. These are pre-configured with factory-set tolerances for safe operation.

Key Parameters:

- **Tolerance:** Determines the amount of movement required for the fader to send a new value.
- **End Stops:** Define the limits of the fader's range of motion.

While the default settings suit most users, you may recalibrate these parameters to better match your preferences or environmental conditions, such as latent noise levels. For guidance on calibrating your fader components, please contact our support team.

3.7 Scope of Delivery and Warranty

Notice

Important Information:

The packaging materials are recyclable. To contribute to environmental sustainability, please dispose of the packaging at a certified recycling facility. Ensure that all storage, shipping, and disposal comply with local regulations. SKAARHOJ assumes no responsibility for any consequences arising from improper storage, shipping, or disposal of the product.

Upon receiving the delivery, carefully inspect the package and its contents for any signs of damage or missing components. Do not accept the delivery if the package is damaged or incomplete. The package should contain the following items:

- (This Product)
- 12V Power Supply: Manufacturer: PHIHONG, Model Name: PSA15R-120P, Output: 12V/1.25A, Cable Length: 1.5m, Adapter type: EU, GB, US, AU depending on shipping country, DC Output Connector: 5.5mm x 2.1mm x 10mm Center Positive
- Getting Started Guide

For details regarding the warranty, please contact your local SKAARHOJ Service Partner. SKAARHOJ is not liable for any issues arising from improper shipping, misuse, or the use of unauthorized third-party products.

3.7.1 Recommended Accessories

- Ethernet Cable: Cat 6 S/FTP or better

3.8 Certification and Safety Standards

3.8.1 EU Declaration of Conformity



Brand Name	SKAARHOJ
Product Description	Universal Control Panel RCP Pro

3.8.2 Regulatory Compliance Information

United States — FCC

This device complies with Part 15 of the FCC Rules. Operation is subject to the following two conditions: (1) this device may not cause harmful interference, and (2) this device must accept any interference received, including interference that may cause undesired operation.

This equipment has been tested and found to comply with the limits for a Class A digital device, pursuant to Part 15 of the FCC Rules. These limits are designed to provide reasonable protection against harmful interference when the equipment is operated in a commercial environment. This equipment generates, uses, and can radiate radio frequency energy and, if not installed and used in accordance with the instruction manual, may cause harmful interference to radio communications. Operation of this equipment in a residential area is likely to cause harmful interference in which case the user will be required to correct the interference at his own expense.

Contains FCC ID: 2ABCB-RPIRMO

Changes or modifications not expressly approved by SKAARHOJ ApS could void the user's authority to operate the equipment.

FCC RF Exposure Statement

This equipment complies with FCC radiation exposure limits set forth for an uncontrolled environment. This equipment should be installed and operated with a minimum distance of 20 cm between the radiator and your body.

Canada — ICES-003 / RSS

This Class A digital apparatus complies with Canadian ICES-003.

Cet appareil numérique de la classe A est conforme à la norme NMB-003 du Canada.

This device contains licence-exempt transmitter(s)/receiver(s) that comply with Innovation, Science and Economic Development Canada's licence-exempt RSS(s). Operation is subject to the following two conditions: (1) this device may not cause interference, and (2) this device must accept any interference, including interference that may cause undesired operation of the device.

L'émetteur/récepteur exempt de licence contenu dans le présent appareil est conforme aux CNR d'Innovation, Sciences et Développement économique Canada applicables aux appareils radio exempts de licence. L'exploitation est autorisée aux deux conditions suivantes : (1) l'appareil ne doit pas produire de brouil-

lage, et (2) l'utilisateur de l'appareil doit accepter tout brouillage radioélectrique subi, même si le brouillage est susceptible d'en compromettre le fonctionnement.

Contains IC: 20953-RPIRMO

Canada RF Exposure Statement

This equipment complies with ISED radiation exposure limits set forth for an uncontrolled environment. This equipment should be installed and operated with a minimum distance of 20 cm between the radiator and your body.

Cet équipement est conforme aux limites d'exposition aux rayonnements ISED établies pour un environnement non contrôlé. Cet équipement doit être installé et utilisé avec un minimum de 20 cm de distance entre la source de rayonnement et votre corps.

European Union

This product is CE marked in accordance with the applicable European Directives including the Radio Equipment Directive (RED) 2014/53/EU. A copy of the EU Declaration of Conformity is available upon request from SKAARHOJ ApS, Rosenkæret 11C, DK-2860 Søborg, Denmark.

Disposal Information

This product is subject to the Waste Electrical and Electronic Equipment (WEEE) Directive. Dispose of this product according to local regulations. Do not dispose of with household waste.

4 Getting Started

This chapter provides a basic guide for setting up the RCP Pro. The steps apply to most SKAARHOJ controllers and are therefore described in general terms.

The basic setup involves:

- Powering on the RCP Pro and accessing it via its IP address
- Discovering and adding devices to be controlled
- Selecting a default configuration

The SKAARHOJ Blue Pill platform enables efficient configuration and control, storing all settings locally within the device. Online communication is only required for software updates or installation of new device cores. All configuration changes can be made over the local network with a web browser.

4.1 Network Requirements

RCP Pro is equipped with a 1 GBit network interface and support 5W-15W PoE (IEEE 802.3af/t) or 12V DC power. Ensure the RCP Pro and client device are on the same subnet (e.g., 192.168.10.*). If multiple SKAARHOJ units are connected to the network, each device should have a unique IP address.

Caution

Power over Ethernet (PoE) Specifications SKAARHOJ controllers use the industry standard PoE (5W-15W, IEEE 802.3af/t). Note that non-standard PoE types, such as certain 24V Ubiquiti models, are incompatible with SKAARHOJ devices. Make sure the PoE switch or injector supports this standard to ensure reliable operation.

4.1.1 Network Layout

We recommend connecting SKAARHOJ Blue Pill controllers to professional PoE network switches, such as the NetGear M4250-series, which efficiently handle AV network traffic. An example network layout for a SKAARHOJ control panel and connected devices, such as a camera, is shown below.

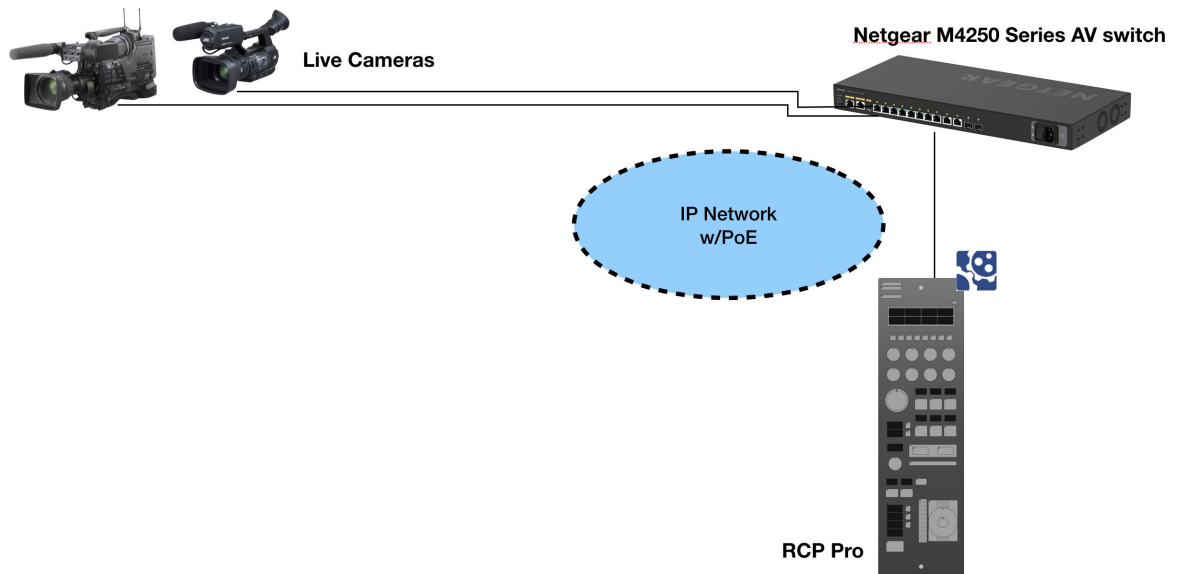

4.2 Accessing RCP Pro

4.2.1 DHCP or Static IP

You can access the RCP Pro 's user interface through its IP address using any web browser. The IP address is shown on one of the displays after it is connected to the network via Power over Ethernet (PoE) or through a network connection and a power supply (5V Micro USB).

By default, the RCP Pro will attempt to obtain an IP address via DHCP. If DHCP is unavailable, the device will automatically use the fallback IP address 192.168.10.99 after some time.



Figure 3: IP address shown for a SKAARHOJ controller.

To access the interface, enter the IP address into the browser's address bar. You will be prompted to enter a username and password. The default credentials are:

- **Username:** admin
- **Password:** skaarhoj

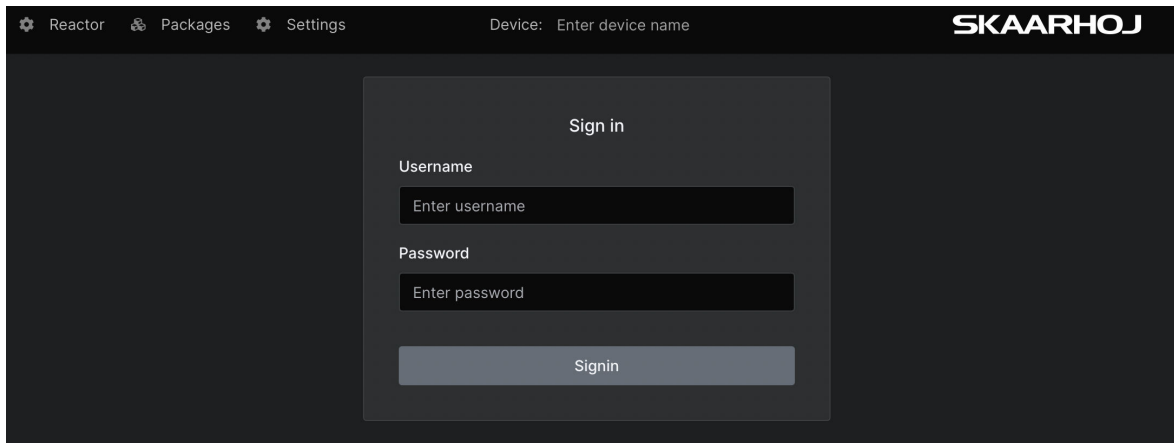

4.2.2 Wi-Fi Access Point

If the RCP Pro does not display an IP address, you can access its web interface by enabling the internal Wi-Fi access point.

To activate the Wi-Fi access point, press and hold the config button (located next to the Ethernet port) for approximately 3 seconds. Use a flat tool, such as a paperclip or small screwdriver. When released, the access point will activate, and the LED will turn purple. The RCP Pro's Wi-Fi network will then appear in your Wi-Fi list as SKAARHOJ-XXXXXX, where "XXXXXX" is the RCP Pro's serial number.

The default Wi-Fi password is **skaarhoj**

After connecting to the Wi-Fi network, access the RCP Pro web interface by entering the IP address 192.168.4.1 into the browser's address bar.

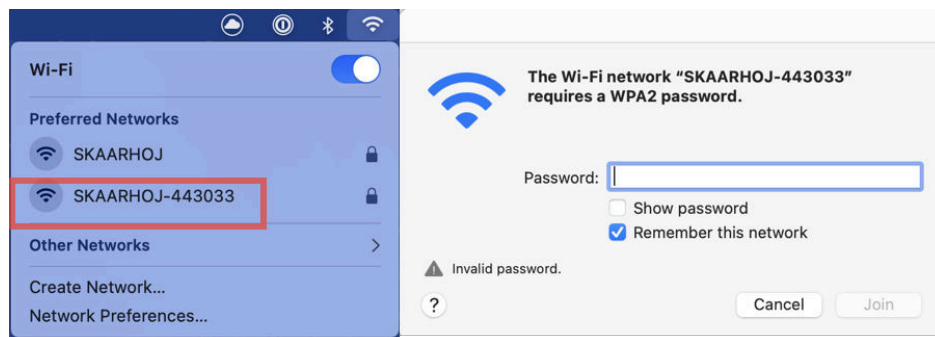

Once you access the RCP Pro interface, navigate to **System Menu > System** to set a static IP address. After saving, the new IP address will display on the RCP Pro's screen. You may need to reboot or power cycle the RCP Pro to apply the new IP address.

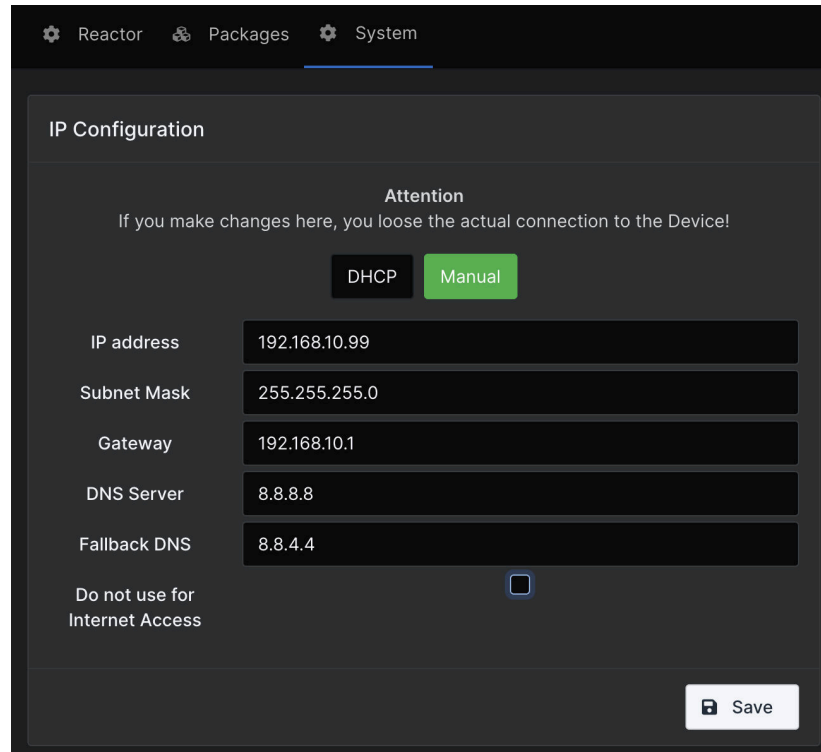

The screenshot displays the 'IP Configuration' section of the SKAARHOJ web interface. At the top, there are navigation tabs for 'Reactor', 'Packages', and 'System'. Below the tabs, the 'IP Configuration' title is followed by an 'Attention' warning: 'If you make changes here, you loose the actual connection to the Device!'. Two buttons, 'DHCP' and 'Manual', are present, with 'Manual' being highlighted in green. Below these are input fields for 'IP address' (192.168.10.99), 'Subnet Mask' (255.255.255.0), 'Gateway' (192.168.10.1), 'DNS Server' (8.8.8.8), and 'Fallback DNS' (8.8.4.4). A checkbox labeled 'Do not use for Internet Access' is currently unchecked. A 'Save' button is located at the bottom right of the configuration area.

IP address	192.168.10.99
Subnet Mask	255.255.255.0
Gateway	192.168.10.1
DNS Server	8.8.8.8
Fallback DNS	8.8.4.4

Do not use for Internet Access

Save

4.2.3 Link from SKAARHOJ Firmware Updater

If the SKAARHOJ Firmware Updater is open on a computer on the same subnet as the RCP Pro, the device should appear in the updater's device list. To open the web interface directly, click on "Configure" next to the panel's information. The RCP Pro does not need to be connected via USB for this feature.

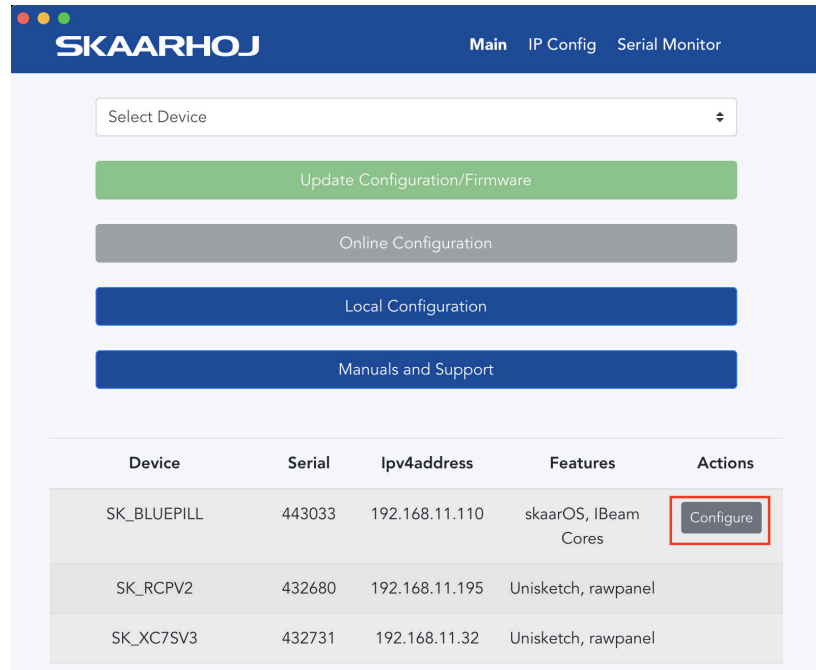

The screenshot shows the SKAARHOJ web interface. At the top, there is a navigation bar with the SKAARHOJ logo and three tabs: "Main", "IP Config", and "Serial Monitor". Below the navigation bar, there is a "Select Device" dropdown menu. Underneath, there are four large buttons: "Update Configuration/Firmware" (green), "Online Configuration" (grey), "Local Configuration" (blue), and "Manuals and Support" (blue). At the bottom, there is a table with the following columns: "Device", "Serial", "Ipv4address", "Features", and "Actions".

Device	Serial	Ipv4address	Features	Actions
SK_BLUEPILL	443033	192.168.11.110	skaarOS, IBeam Cores	Configure
SK_RCPV2	432680	192.168.11.195	Unisketch, rawpanel	
SK_XC7SV3	432731	192.168.11.32	Unisketch, rawpanel	

4.2.4 SKAARHOJ Firmware Updater and Micro USB

If the network is not available, you can set the IP address using a Micro USB cable. Connect the RCP Pro to your computer, where it will appear in the “Select Device” dropdown of the Firmware Updater. From there, go to the “IP Config” tab to set the IP address.



The screenshot shows the SKAARHOJ web interface with the "IP Config" tab selected. The navigation bar at the top shows "Main", "IP Config", and "Serial Monitor". Below the navigation bar, there is a dropdown menu displaying the device path: "/dev/tty.usbmodem4430361 (SKAARHOJ)".

For example, on MacOS, the RCP Pro might appear as “/dev/tty.usbmodem4430361” . Clicking “IP Config” opens the IP setup page.



SKAARHOJ Main IP Config Serial Monitor

IP Configuration

Use DHCP Enable

IP Address 10.11.12.13 ✓

Subnet Mask 255.255.255.0 ✓

Gateway 10.11.12.0 ✓

DNS Server 8.8.8.8 ✓

Device Cores

Cancel Save Settings

If a warning appears, click “Submit” and reboot the RCP Pro to apply the settings.

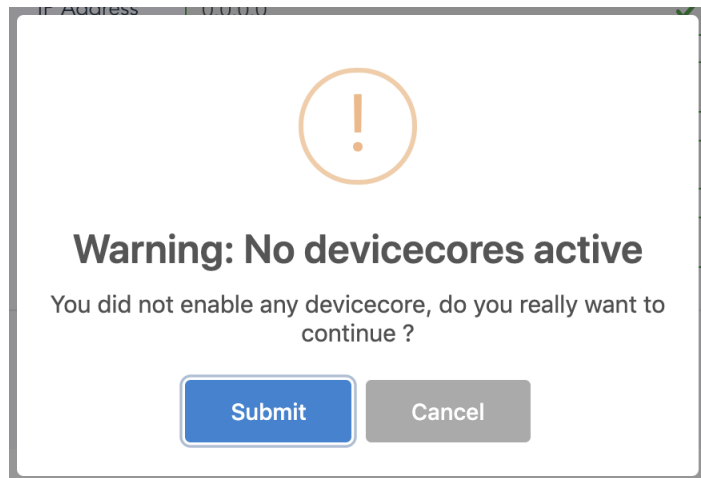

4.3 Selecting Default Configuration

The RCP Pro’s function is determined by its configuration, which is selected through a drop down on the Home Screen. In most cases, the **Generic** configuration is sufficient. However, for specific panel and device combinations, dedicated configurations may be available.

To select the default configuration, use the dropdown menu next to the panel.

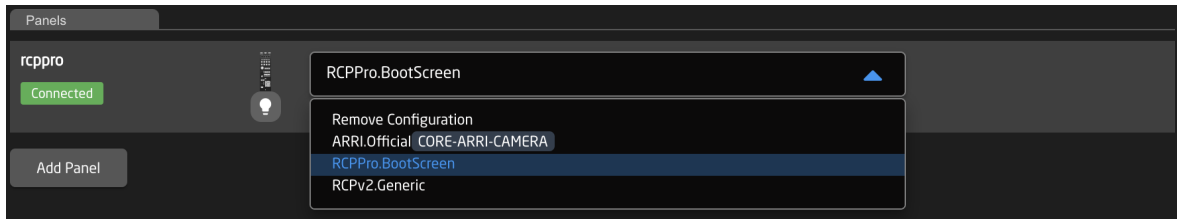

4.4 Adding Devices

There are two main ways to add devices to a new RCP Pro setup: **Auto Discover** and **Manual Add**.

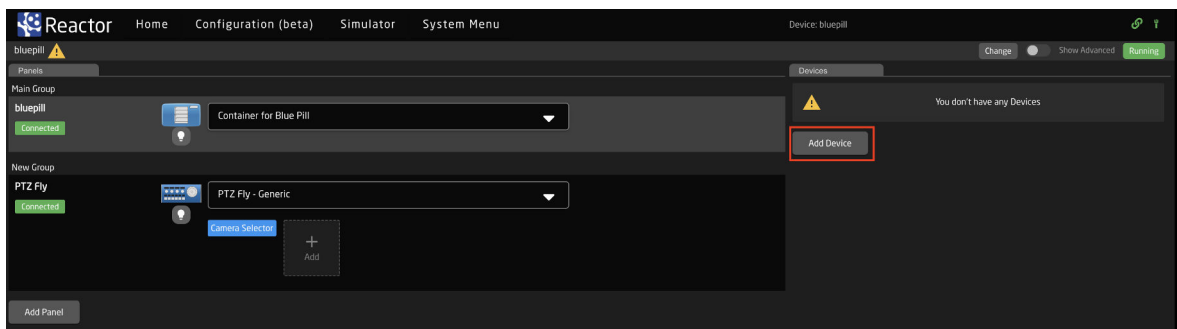

4.4.1 Auto Discover

The Auto Discover feature scans the network for compatible devices using mDNS and other discovery methods. While not all devices are discoverable this way, those that are can be added to the RCP Pro's device list with a single click. After adding a device via Auto Discover, you may still need to input certain details to establish connectivity. See Section 4.4.3 for further setup information.

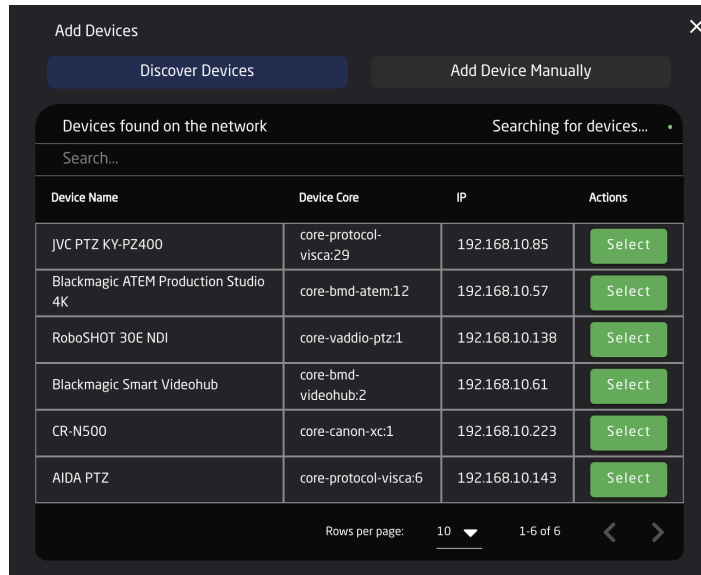

To select multiple devices, hold **SHIFT** and click the green **Select** button.

4.4.2 Manual Add

If a device is not discoverable, it can be added manually. Simply look up the device model in the list of supported devices and enter the IP address along with any other required details. See Section 4.4.3 for further setup.

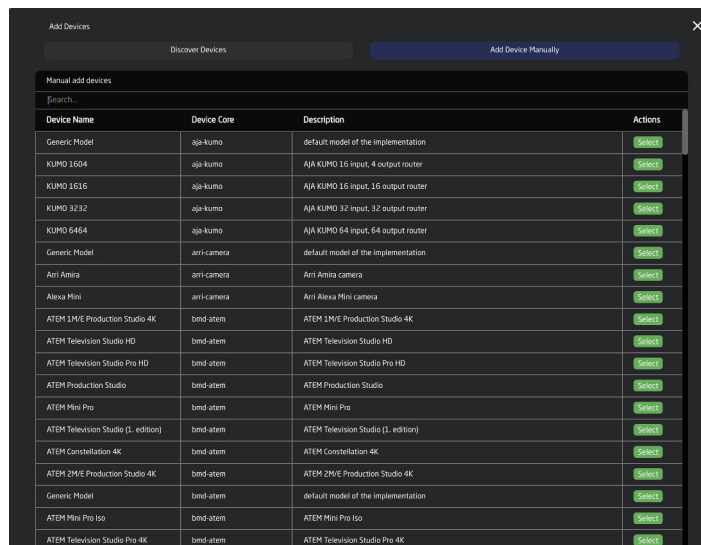

To add multiple devices manually, hold **SHIFT** and click the green **Add Device** button.

4.4.3 Device Details

Each device's status is displayed in the overview on the Home screen.

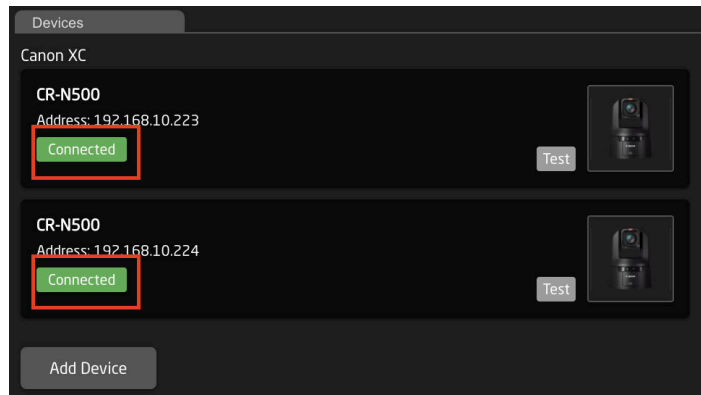

Clicking on a device's name in the **Devices** section opens the device details. Here, you can modify the device's **Name**, **ID**, and **Active Status**. By default, the device name matches the model, the ID is assigned in sequence, and the status is set to active. A device must be active to function.

When applicable, you can enter a specific username and password for device connectivity. If these fields are left blank, the RCP Pro will attempt to connect using the device's default credentials.

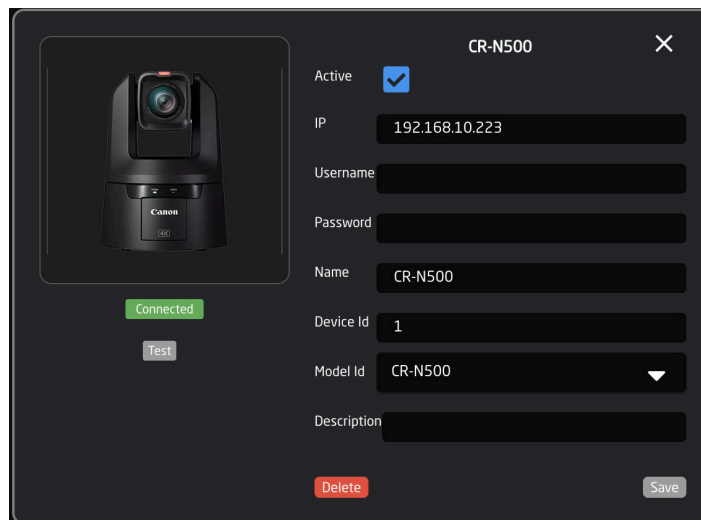

4.4.4 Populating Settings Tables

The final step in configuring the RCP Pro is filling in any **Settings Tables**. These tables are available based on the selected configuration and allow you to specify details such as specific cameras for a PTZ controller or input/output settings for a video switcher. Settings tables are most commonly used for PTZ cameras and routing panels, though they may also apply to other configurations.

Once populated, the settings will auto-save and instantly appear on the panel's displays, enabling functionality.

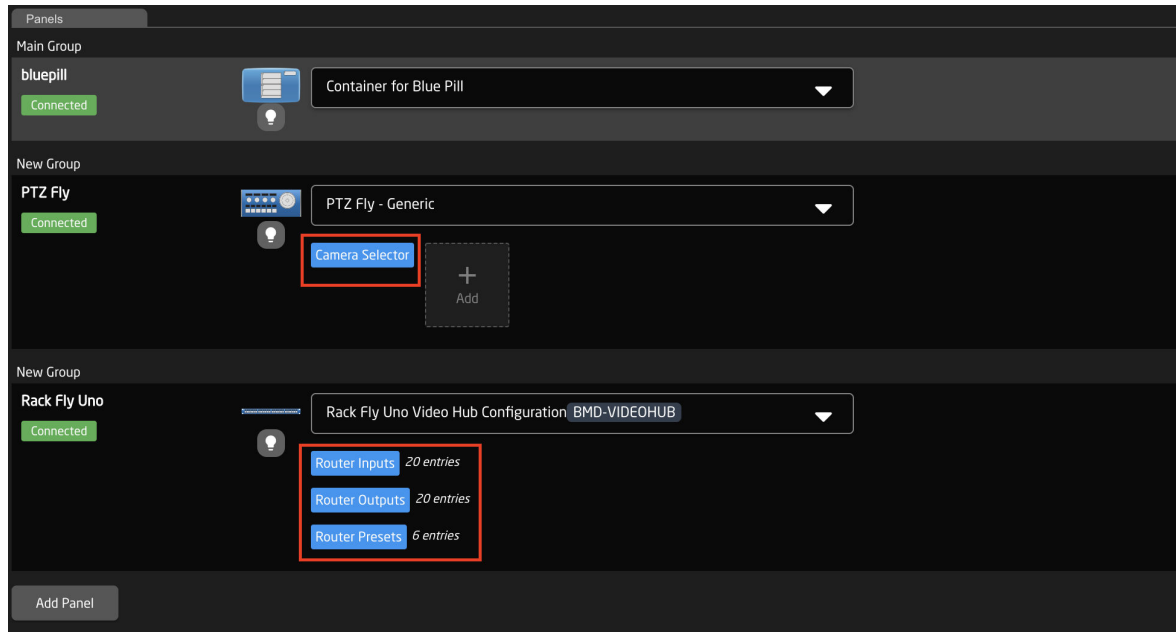

For example, the Camera Selector table enables you to configure specific cameras, adjust their order on the selector row, and assign display names. The columns are described in Table 2.

The screenshot shows the 'Camera Selector' configuration window. It contains a table with the following columns: Drag, Mute, Binding, Device Number, Camera name, Use device configuration, Configuration for Iris/Master black channels, Tally Index, and FrameLink Window.

Drag	Mute	Binding	Device Number	Camera name	Use device configuration	Configuration for Iris/Master black channels	Tally Index	FrameLink Window
		CR-N500	1	CR-N500	SKAARHOJ Devices.Canon-XC.StdClass.basic	SKAARHOJ Devices.Canon-XC.IrisChannel		
		CR-N500	2	CR-N500	SKAARHOJ Devices.Canon-XC.StdClass.basic	SKAARHOJ Devices.Canon-XC.IrisChannel		

A 'NEW' button is located at the bottom center of the table.

The Router Input and Output tables allow configuration of input/output settings, custom display names, and button colors. The columns are described in Table 3.

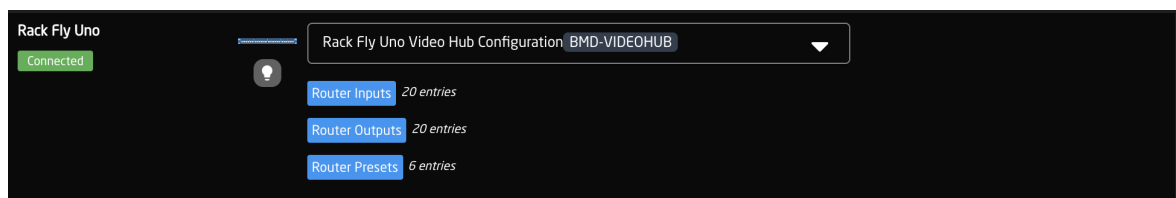

Column	Description
Drag	Rearranges camera order; right-clicking allows row deletion.
Mute	Disables access to specific cameras or leaves a blank spot.
Binding	Selects a connected camera.
Camera Name	Customizable display name, character limit varies by display size.
Device Number	Links to the specific device; auto-populates with camera selection in Binding.
Link Selector	Assigns protocol configuration for the camera.
Channel Link	Selects protocol for Iris/Master Black control (not available in all classes).
Tally Index	Connects to the corresponding tally source device (optional).
Route Index	Connects with a routing device (optional).
FrameLink Window	Associates with FrameLink device core (optional).

Table 2: Columns in the Camera Selector settings table.

Column	Description
Drag	Rearranges input/output order; right-clicking allows row deletion.
Mute	Disables access to specific inputs/outputs or leaves a blank spot.
Output Number/Input Number	Connects to a specific input/output, determined by the router.
Alternative Label	Customizable display name; character limit varies by display size.
Color	Sets button feedback color; options include OFF, WHITE, WARM, RED, ROSE, PINK, PURPLE, AMBER, YELLOW, DARKBLUE, BLUE, ICE, CYAN, SPRING, GREEN, MINT. Use uppercase format with no spaces.

Table 3: Columns in the Router Input and Output settings tables.

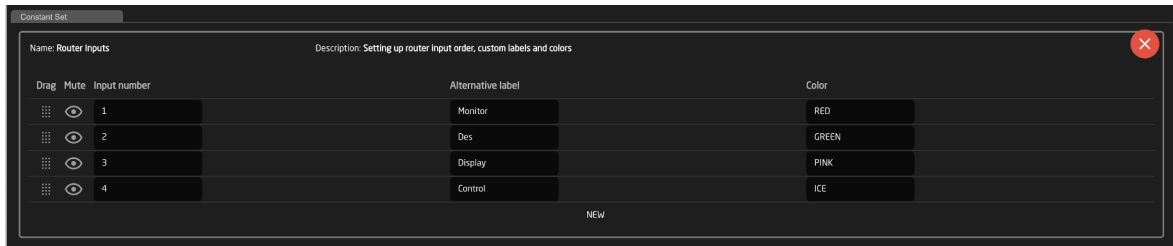

4.5 Beyond Default Configurations

SKAARHOJ controllers are versatile across models, allowing for default configurations and additional device integration.

Given the wide range of configurations possible, documenting each is impractical. For setup guidance with specific devices on your SKAARHOJ panel, please refer to the resources available on our [wiki pages](#).

To further customize your RCP Pro, explore the advanced options in the **Configuration Tab** in Reactor. For detailed guidance, we recommend our online tutorials and additional resources at wiki.skaarhoj.com.

5 Service

5.1 Troubleshooting

For troubleshooting tips, please refer to our online Wiki:

<https://wiki.skaarhoj.com/books/blue-pill-reactor/chapter/troubleshooting>

5.2 Cleaning

Proper cleaning and maintenance of your RCP Pro are critical to ensuring its durability and optimal performance. Regular cleaning, when done with care and the right materials, will help maintain the device in excellent working condition. On the other hand, improper cleaning techniques or the use of harsh chemicals can lead to permanent damage to surfaces, connectors, and labels. To prevent wear and tear, it is important to adhere to the cleaning recommendations outlined in this section.

Notice

Proper Cleaning of RCP Pro

To avoid surface damage, follow these guidelines:

- **Disconnect all accessories and cables** before cleaning.
- **Only use the recommended cleaning agents** listed in this section.
- **Avoid harsh chemicals** like Methanol, Acetone, Benzine, or acids. These substances may damage labels, paint, and polished surfaces.
- **Keep connectors dry** —do not moisten connectors or expose them to cleaning liquids.
- **Avoid touching connector pins** directly while cleaning.
- **Air-blow dust from connectors** before wiping them. Use deionized air if static charge is present.
- **Do not use compressed air** on the housing, as it can push dust into the device.

Recommended Cleaning Agents:

- Water
- Glass Cleaner
- Isopropyl Alcohol

To maintain the longevity and optimal performance of your RCP Pro, it is essential to follow proper cleaning guidelines. Different areas of the device require specific cleaning methods to avoid damage

to sensitive components. The following table outlines the recommended cleaning procedures for key areas of the device.

Area	Recommended Cleaning Procedure
Housing	Wipe the housing and external accessories with a soft, lint-free cloth and a mild cleaner like water or glass cleaner. When necessary, use isopropyl alcohol to remove tough residues, such as adhesive or dirt buildup.
Narrow spaces and gaps	Use a manual air blower or a soft brush to gently remove dust from gaps and tight spaces. For delicate areas, cotton swabs may also be used.

Table 4: Proper cleaning methods for RCP Pro

By following these cleaning instructions, you can avoid damaging your device and its components. Routine maintenance will keep your RCP Pro in top condition and reduce the likelihood of damage that could lead to costly repairs or replacements.

5.3 Repair

In addition to proper cleaning, it is also important to be cautious when it comes to repairs. Performing repairs without the necessary expertise can result in personal injury and may further damage the device.

Warning

Repairs by Untrained Personnel

Attempting to repair the device without proper training can lead to injury and product damage:

- **Only perform maintenance tasks** described in this manual.
- **Do not attempt repairs yourself** —all repairs must be carried out by authorized SKAARHOJ service partners.
- **Warranty is void** if unauthorized repairs are attempted.

Repairs and maintenance should always be conducted by professionals trained to handle the RCP Pro. If you encounter any issues requiring repair, we highly recommend contacting SKAARHOJ's authorized service partners. Unauthorized repairs may void the warranty, cause further damage, and pose significant safety risks.

To keep your RCP Pro functioning optimally, always refer to this manual for proper cleaning and repair procedures. For any work beyond the scope of this manual, please contact SKAARHOJ Support team for assistance.

5.4 Disposal

Notice

Disposal of the Product

You can return the product at your own expense to the manufacturer, SKAARHOJ ApS, for disposal. Always follow local guidelines and laws for proper disposal.

Proper disposal of electronic equipment is essential to reduce environmental impact and ensure that hazardous materials are handled safely. Different countries may have specific laws and guidelines regarding electronic waste disposal. It is important to familiarize yourself with these rules to ensure compliance and minimize risks to both health and the environment.

When disposing of third-party accessories, always consult the instructions provided by the relevant manufacturers to ensure safe and compliant disposal practices.



This product falls within the scope of Directive 2012/19 / EU OF THE EUROPEAN PARLIAMENT AND OF THE COUNCIL of June 4, 2012 on waste electrical and electronic equipment (WEEE II).

Accordingly, this product must not be disposed of with household waste. Always adhere to country-specific disposal rules and ensure proper recycling or disposal through authorized facilities.

In addition to the general guidelines provided above, the product must always be disposed of in accordance with local electronic waste regulations. The WEEE Directive sets the framework for the handling of waste electrical and electronic equipment across EU member states. It ensures that electronics are collected and treated separately from household waste to minimize environmental harm.

5.5 Transportation and Storage

Notice

Proper Handling of RCP Pro

To avoid the risk of product damage:

- Follow the recommended environmental conditions at all times.
- Use an appropriate case for transporting the product and its accessories.
- Adhere to the transport and storage guidelines outlined in this section.

Ensuring proper transportation and storage of your RCP Pro is critical to maintaining its performance and longevity. Mishandling the device or its accessories can lead to damage. Please follow these guidelines to protect your equipment during transportation and storage.

Transportation Guidelines:

- Detach all accessories from the product before transport.
- Always transport the product in a protective case designed for its dimensions.
- Avoid exposing the product to strong shocks or impacts during transport.
- Keep the product within the recommended temperature range.

Storage Guidelines:

- Remove all accessories before storing.
- Disconnect all cables and power sources from the product.
- Store the product in a protective case.
- Keep the product within the recommended temperature range.
- Avoid storing the product in environments exposed to extreme temperatures, direct sunlight, high humidity, excessive vibration, dust, or strong magnetic fields.

5.6 SKAARHOJ Service Contacts

For any inquiries, technical support, or service requests regarding your RCP Pro, please reach out to our support team. Our dedicated professionals are ready to assist you with troubleshooting, repairs, and general product information. You can find the contact details for SKAARHOJ below.

SKAARHOJ ApS

Rosenkaeret 11C
DK-2860 Soeborg
Denmark
Email: support@skaarhoj.com
Website: www.skaarhoj.com

SKAARHOJ Inc

2600 W Olive Avenue Suite 500
Burbank, CA 91505
USA
Email: support@skaarhoj.com
Website: www.skaarhoj.com

6 Notes
